

Machining of **aluminium and non-ferrous metals**
*Bearbeitung von **Aluminium und NE-Metallen***



ZCC Cutting Tools Europe GmbH

your Partner | your Value



The new gold-polished PVD coating was specially developed for the machining of aluminium and AL-alloys. Together with a highly wear-resistant carbide grade it gives an extra-smooth surface which controls the development of built-up edges.

Die neue gold-glänzende PVD Beschichtung wurde speziell für die Bearbeitung von Aluminium und Aluminiumlegierungen entwickelt. Auf der hochverschleißfesten Hartmetallsorte führt sie zu einer extrem glatten Oberfläche, die gegen die Entwicklung von Aufbauschneiden wirkt.

YBG102

PVD grade for the machining of Aluminium and AL-alloys (Si \geq 12%).

PVD Sorte für die Bearbeitung von Aluminium und Aluminiumlegierungen (Si \geq 12%).

YD101

Substrate of YD101 - the combination of cemented WC carbide phase of fine grain and Co bonding phase.

YD101 ist ein unbeschichtetes Hartmetall aus Wolframcarbide mit feiner Körnung und einer Bindefase aus Kobalt.

YD201

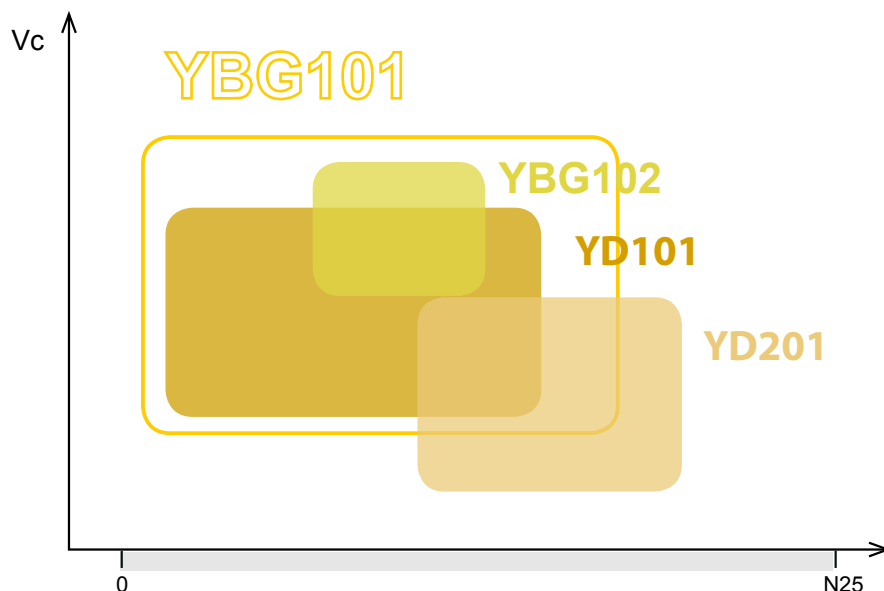

Substrate of YD201 - the combination of cemented WC carbide phase of medium grain and Co bonding phase.

YD201 ist ein unbeschichtetes Hartmetall mit mittlerer Korngröße, aus Wolframcarbide und einer speziell entwickelten Hartphase, die zusammen mit Kobalt, welches die Bindefase erzeugt, das Hartmetallgefüge bildet.





Turning · Drehen

CC** Positive Insert/ Positive WSP

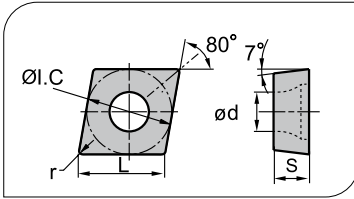
 Ideal Machining Condition / Gute Bearbeitungsbedingungen
  Normal Machining Condition / Normale Bearbeitungsbedingungen
  Unfavorable Machining Condition / Ungünstige Bearbeitungsbedingungen



Workpiece Material / Werkstoffe	Material	Condition
P	Steel / Stahl	●
M	Stainless Steel / Rostfreier Stahl	●
K	Cast iron / Gusseisen	●
N	Non-ferrite material / Ne Metalle	● ● ●
S	Heat-resistant steel / Warmfester Stahl	● ● ●

Insert Shape / Schneidplattenform	Type · Typ	Dimension (mm) / Abmessung					Coated Carbide / Beschichtetes Hartmetall			Cermet unbeschichtet	Cermet Beschicht. Ceram.	Uncoated Carbide unbeschicht. Hartmetall
		L	I.C	S	d	r	YBG101	YBG102	YBG202			
LC 	CCGX060202-LC	6.4	6.35	2.38	2.8	0.2	●					●
	CCGX060204-LC	6.4	6.35	2.38	2.8	0.4	●					●
	CCGX09T302-LC	9.7	9.525	3.97	4.4	0.2	●					●
	CCGX09T304-LC	9.7	9.525	3.97	4.4	0.4	●					●
	CCGX09T308-LC	9.7	9.525	3.97	4.4	0.8	●					●
	CCGX120404-LC	12.9	12.7	4.76	5.5	0.4	●					●
	CCGX120408-LC	12.9	12.7	4.76	5.5	0.8	●					●
LH 	CCGX060202-LH	6.4	6.35	2.38	2.8	0.2	●					●
	CCGX060204-LH	6.4	6.35	2.38	2.8	0.4	●					●
	CCGX060208-LH	6.4	6.35	2.38	2.8	0.8						●
	CCGX09T302-LH	9.7	9.525	3.97	4.4	0.2	●					●
	CCGX09T304-LH	9.7	9.525	3.97	4.4	0.4	●					●
	CCGX09T308-LH	9.7	9.525	3.97	4.4	0.8	●					●
	CCGX120402-LH	12.9	12.7	4.76	5.56	0.2	○					○
	CCGX120404-LH	12.9	12.7	4.76	5.56	0.4	●					●
	CCGX120408-LH	12.9	12.7	4.76	5.56	0.8	● ○					●
	CCGX120412-LH	12.9	12.7	4.76	5.56	1.2	○					●

● Ex Stock / ab Lager ○ On demand / auf Anfrage

DC** Positive Insert/ Positive WSP

● Ideal Machining Condition / Gute Bearbeitungsbedingungen
 ● Normal Machining Condition / Normale Bearbeitungsbedingungen
 ● Unfavorable Machining Condition / Ungünstige Bearbeitungsbedingungen

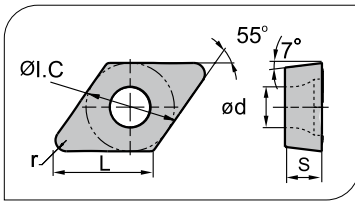

Workpiece Material / Werkstoffe	Steel / Stahl	Stainless Steel / Rostfreier Stahl	Cast iron / Gusseisen	Non-ferrous material / Ne Metalle	Heat-resistant steel / Warmfester Stahl
P	●	●	●	●	●
M	●	●	●	●	●
K	●	●	●	●	●
N	●	●	●	●	●
S	●	●	●	●	●

Insert Shape / Schneidplattenform	Type · Typ	Dimension (mm) / Abmessung					Coated Carbide / Beschichtetes Hartmetall			Cermet unbeschichtet	Cermet beschicht. Cermet	Uncoated Carbide unbeschicht. Hartmetall
		L	I.C	S	d	r	YBG101	YBG102	YBG202			
	DCGX070201-LC	7.8	6.35	2.38	2.8	0.1						●
	DCGX070202-LC	7.8	6.35	2.38	2.8	0.2	●					●
	DCGX070204-LC	7.8	6.35	2.38	2.8	0.4	●					●
	DCGX11T302-LC	11.6	9.525	3.97	4.4	0.2	●					●
	DCGX11T304-LC	11.6	9.525	3.97	4.4	0.4	●					●
	DCGX11T308-LC	11.6	9.525	3.97	4.4	0.8	●					●
	DCGX070202-LH	7.8	6.35	2.38	2.8	0.2	●	○				●
	DCGX070204-LH	7.8	6.35	2.38	2.8	0.4	●	○				●
	DCGX070208-LH	7.8	6.35	2.38	2.8	0.8		○				●
	DCGX11T302-LH	11.6	9.525	3.97	4.4	0.2	●	●				●
	DCGX11T304-LH	11.6	9.525	3.97	4.4	0.4	●	●				●
	DCGX11T308-LH	11.6	9.525	3.97	4.4	0.8	●	○				●

● Ex Stock / ab Lager ○ On demand / auf Anfrage

SC** Positive Insert/ Positive WSP

● Ideal Machining Condition / Gute Bearbeitungsbedingungen
 ● Normal Machining Condition / Normale Bearbeitungsbedingungen
 ● Unfavorable Machining Condition / Ungünstige Bearbeitungsbedingungen

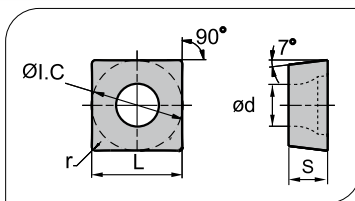

Workpiece Material / Werkstoffe	Steel / Stahl	Stainless Steel / Rostfreier Stahl	Cast iron / Gusseisen	Non-ferrous material / Ne Metalle	Heat-resistant steel / Warmfester Stahl
P	●	●	●	●	●
M	●	●	●	●	●
K	●	●	●	●	●
N	●	●	●	●	●
S	●	●	●	●	●

Insert Shape / Schneidplattenform	Type · Typ	Dimension (mm) / Abmessung					Coated Carbide / Beschichtetes Hartmetall			Cermet unbeschichtet	Cermet beschicht. Cermet	Uncoated Carbide unbeschicht. Hartmetall
		L	I.C	S	d	r	YBG101	YBG102	YD101			
	SCGX09T304-LC	9.525	9.525	3.97	4.4	0.4						●
	SCGX09T308-LC	9.525	9.525	3.97	4.4	0.8						●
	SCGX120408-LC	12.7	12.7	4.76	5.5	0.8	●					●
	SCGX09T302-LH	9.525	9.525	3.97	4.4	0.2		○				●
	SCGX09T304-LH	9.525	9.525	3.97	4.4	0.4		○				●
	SCGX09T308-LH	9.525	9.525	3.97	4.4	0.8						●
	SCGX120408-LH	12.7	12.7	4.76	5.56	0.8		○				●

General Turning / Allgemeine Drehbearbeitung

Turning · Drehen

TC** Positive Insert/ Positive WSP

● Ideal Machining Condition / Gute Bearbeitungsbedingungen ● Normal Machining Condition / Normale Bearbeitungsbedingungen ● Unfavorable Machining Condition / Ungünstige Bearbeitungsbedingungen

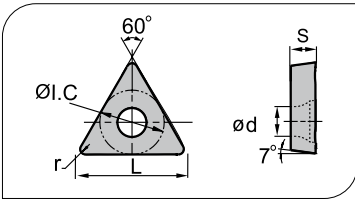

Workpiece Material / Werkstoffe	Steel / Stahl	Stainless Steel / Rostfreier Stahl	Cast iron / Gusseisen	Non-ferrite material / Ne Metalle	Heat-resistant steel / Warmfester Stahl
P	●	●	●	●	●
M	●	●	●	●	●
K	●	●	●	●	●
N	●	●	●	●	●
S	●	●	●	●	●

Insert Shape / Schneidplattenform	Type · Typ	Dimension (mm) / Abmessung					Coated Carbide / Beschichtetes Hartmetall		Cermet unbeschichtet	Cermet Beschicht. Cermet	Uncoated Carbide unbeschicht. Hartmetall
		L	I.C	S	d	r	YBG101	YBG102			
	TCGX090202-LC	9.6	5.56	2.38	2.5	0.2	●				●
	TCGX090204-LC	9.6	5.56	2.38	2.5	0.4	●				●
	TCGX110202-LC	11	6.35	2.38	2.8	0.2	●				●
	TCGX110204-LC	11	6.35	2.38	2.8	0.4	●				●
	TCGX110208-LC	11	6.35	2.38	2.8	0.8	●				●
	TCGX16T304-LC	16.5	9.525	3.97	4.4	0.4	●				●
	TCGX16T308-LC	16.5	9.525	3.97	4.4	0.8	●				●
	TCGX090202-LH	9.6	5.56	2.38	2.5	0.2	○				●
	TCGX090204-LH	9.6	5.56	2.38	2.5	0.4	○				●
	TCGX110202-LH	11	6.35	2.38	2.8	0.2	●				●
	TCGX110204-LH	11	6.35	2.38	2.8	0.4	●				●
	TCGX16T302-LH	16.5	9.525	3.97	4.4	0.2	○				●
	TCGX16T304-LH	16.5	9.525	3.97	4.4	0.4	○				●
	TCGX16T308-LH	16.5	9.525	3.97	4.4	0.8	○				●

RC** Positive Insert/ Positive WSP

● Ideal Machining Condition / Gute Bearbeitungsbedingungen ● Normal Machining Condition / Normale Bearbeitungsbedingungen ● Unfavorable Machining Condition / Ungünstige Bearbeitungsbedingungen

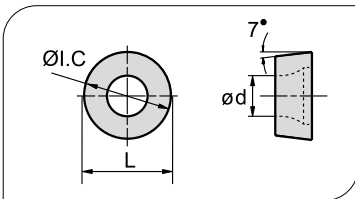

Workpiece Material / Werkstoffe	Steel / Stahl	Stainless Steel / Rostfreier Stahl	Cast iron / Gusseisen	Non-ferrite material / Ne Metalle
P	●	●	●	●
M	●	●	●	●
K	●	●	●	●
N	●	●	●	●

Insert Shape / Schneidplattenform	Type · Typ	Dimension (mm) / Abmessung					Coated Carbide / Beschichtetes Hartmetall		Cermet unbeschichtet	Cermet Beschicht. Cermet	Uncoated Carbide unbeschicht. Hartmetall
		L	I.C	S	d	r	YBG101	YBG102			
	RCGX0803MO-LH	8.0	8.0	3.18	3.36	4.0					●
	RCGX1204MO-LH	12	12	4.76	4.4	4.0					●

● Ex Stock / ab Lager ○ On demand / auf Anfrage

PCD

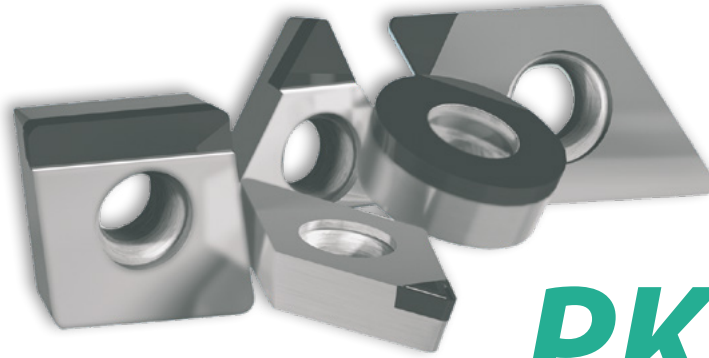

PKD

Properties of PCD • CVD-D

Diamond is the hardest known cutting material. It is a synthetic material which is a result of a high temperature and pressure processes. The finished product consists of one carbide layer and one PCD thick-layer.

This combination of the two materials is called Poly-Crystalline-Diamond (PCD) wafer. PCD, CVD-D is used in non-ferrous and precious metal and similar materials like aluminum, aluminum reinforced silicon alloys (MMC) and Copper. It is also used in nonmetals like plastic-materials, wood, fiberglass, mineral material, stone and ceramic. PCD, CVD-D tipped tools are used if high cutting conditions in combination with high tool life, high surface quality and tight tolerances are required.

Eigenschaften von PKD • CVD-D

Diamant, bekannt als das härteste Material, liegt hier als gesinterte polykristalline Diamantschicht vor. Mit Hilfe eines speziellen Hochdruck-Hochtemperatur-Verfahrens wird eine dichte Lage aus polykristallinen Diamanten auf Hartmetall als Trägermaterial aufgebracht.

PKD und CVD-Diamantschneidplatten finden Anwendung in der Bearbeitung von Nicht-Eisen-Metallen [Aluminiumlegierungen, Kupferlegierungen] und nicht-Metallen [faserverstärkte Kunststoffe (GFK, CFK), Hartgummi, Holz, Mehrlagen-Schichtverbunde (Faserplatten, Melaminharz-Verbundstoffe), faserpartikelverstärkte Metalle (MMC)]. Durch den Einsatz von PKD, CVD-D bestückten Werkzeugen werden höchste Schnittgeschwindigkeiten, Standzeiten, Oberflächengüten und Maßgenauigkeiten erreicht.

CVD-Diamond for highest wear resistance and hardness for special application.

CVD-Diamant für höchste Verschleißfestigkeit und Härte für spezielle Anwendungen.

Wear resistance
Verschleißfestigkeit

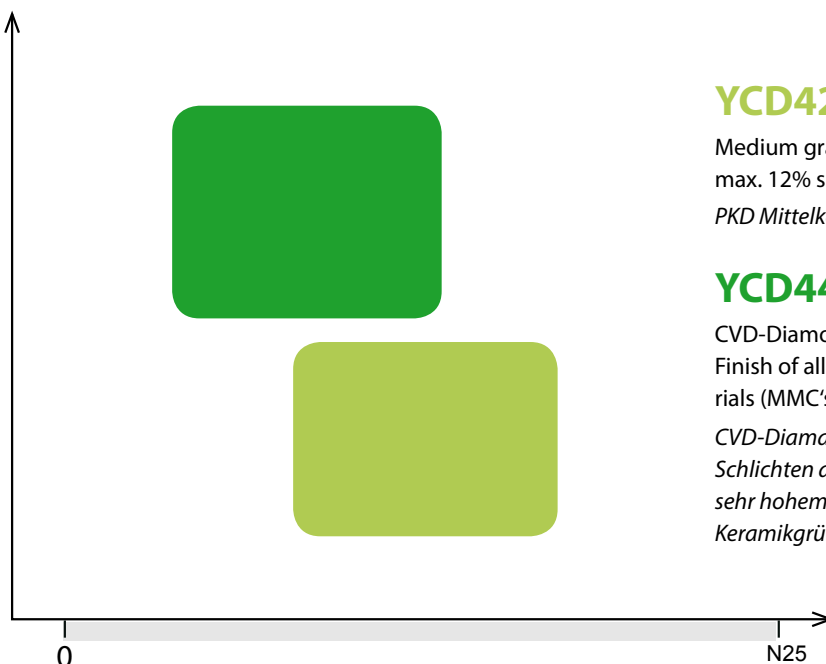

YCD421 (on demand / auf Anfrage)

Medium grain size, used in 90% of all applications, max. 12% silicon content

PKD Mittelkorn, Standard PKD-Qualität, AISi max. 12%

YCD441 (on demand / auf Anfrage)

CVD-Diamond

Finish of all nonferrous metals AISi > 12% reinforced materials (MMC's) solid carbide, ceramic greenparts

CVD-Diamant

Schichten aller Ne - Metalle AISi > 12%, Werkstoffe mit sehr hohem Anteil abrasiver Füllstoffe (MMC's) Hartmetall, Keramikgrünlinge

Insert Shape Schneidplattenform	Zeichnung drawing	Type Typ	L	S	R	D	W	SL	YCD421
		CCGT060202**	6,40	2,38	0,20	6,35	7°	3	●
		CCGT060204**	6,40	2,38	0,40	6,35	7°	3	●
		CCGT09T304**	9,70	3,97	0,40	9,52	10°	4	●
		CCGT09T308**	9,70	3,97	0,80	9,52	10°	4	○
		CCGT120404**	12,90	4,76	0,40	12,70	10°	4	●
		CCGT120408**	12,90	4,76	0,80	12,70	10°	4	○
		CCGW060202**	6,40	2,38	0,20	6,35	0°	3	●
		CCGW060204**	6,40	2,38	0,40	6,35	0°	3	●
		CCGW09T304**	9,70	3,97	0,40	9,52	0°	4	●
		CCGW09T308**	9,70	3,97	0,80	9,52	0°	4	●
		CCGW120404**	12,90	4,76	0,40	12,70	0°	4	●
		CCGW120408**	12,90	4,76	0,80	12,70	0°	4	●
		DCGT070202**	7,75	2,38	0,20	6,35	7°	3	●
		DCGT070204**	7,75	2,38	0,40	6,35	7°	3	●
		DCGT11T302**	11,60	3,97	0,20	9,52	10°	4	●
		DCGT11T304**	11,60	3,97	0,40	9,52	10°	4	●
		DCGT11T308**	11,60	3,97	0,80	9,52	10°	4	●
		DCGW070202**	7,75	2,38	0,20	6,35	0°	3	●
		DCGW070204**	7,75	2,38	0,40	6,35	0°	3	●
		DCGW070208**	7,75	2,38	0,80	6,35	0°	3	●
		DCGW11T302**	11,60	3,97	0,20	9,52	0°	4	●
		DCGW11T304**	11,60	3,97	0,40	9,52	0°	4	●
		DCGW11T308**	11,60	3,97	0,80	9,52	0°	4	●
		TCGT110202**	11,00	2,38	0,20	6,35	7°	4	○
		TCGT110204**	11,00	2,38	0,40	6,35	10°	4	○
		TCGT16T304**	16,50	3,97	0,40	9,52	10°	4	○
		TCGT16T308**	16,50	3,97	0,80	9,52	10°	4	○
		TCGW110208**	11,00	2,38	0,80	6,35	0°	4	○
		TCGW16T304**	16,50	3,97	0,40	9,52	0°	4	○
		TCGW16T308**	16,50	3,97	0,80	9,52	0°	4	○
		VBGT160402**	16,60	4,76	0,20	9,52	10°	4,50	○
		VBGT160404**	16,60	4,76	0,40	9,52	10°	4,50	○
		VBGT160408**	16,60	4,76	0,80	9,52	10°	4,50	○
		VCGT160402**	16,60	4,76	0,20	9,52	10°	4,50	○
		VCGT160404**	16,60	4,76	0,40	9,52	10°	4,50	●
		VCGT160408**	16,60	4,76	0,80	9,52	10°	4,50	●
		VBGW160404**	16,60	4,76	0,40	9,52	0°	4,50	●
		VBGW160408**	16,60	4,76	0,80	9,52	0°	4,50	●
		VCGW160404**	16,60	4,76	0,40	9,52	0°	4,50	●
		VCGW160408**	16,60	4,76	0,80	9,52	0°	4,50	●

Recommended cutting datas PCD/CVD-D Schnittdatenempfehlung für PKD/CVD-D

Work piece material	Werkstoff	Vc (m/min.)		ap mm	f (mm/U)*	
Aluminum alloys Aluminium Si<12%	Aluminiumlegierungen Aluminium Si<12%	Turning (rough)	Vordrehen	800-3000	0,3-5,0	0,1-0,6
		Turning (finish)	Fertigdrehen	800-3000	0,05-1,0	0,03-0,2
		Milling	Fräsen	800-3500	0,1-2,5	0,05-0,3
Aluminum with high Silicon content Si >12%	hochsiliziumhaltiges Aluminium Si >12%	Turning (rough)	Vordrehen	300-900	0,1-2,5	0,1-0,4
		Turning (finish)	Fertigdrehen	300-900	0,05-0,8	0,03-0,2
		Milling	Fräsen	400-1000	0,1-2,0	0,05-0,3
Copper alloys, Bronze, brass, tin-foil, copper, zinc alloys, magnesium alloys	Kupferlegierungen, Bronze, Messing, Weißblech, Kupfer, Zinklegierungen Magnesiumlegierungen	Turning (rough)	Vordrehen	600-1200	0,5-2,0	0,1-0,4
		Turning (finish)	Fertigdrehen	700-1500	0,05-0,5	0,05-0,4
		Milling	Fräsen	700-1200	0,1-2,5	0,1-0,3
Carbide up to 15% cobalt	Hartmetalle bis max. 15% Cobaltgehalt	Turning (rough)	Vordrehen	20-25	0,1-0,5	0,1-0,3
		Turning (finish)	Fertigdrehen	20-30	0,05-0,2	0,05-0,2
Ebonite, glass, ceramic, graphite, plastic-materials (GFK, CFK), fiber-glass (PVC, PA, PE),	Hartgummi, Glas, Keramik, Graphit, faserverstärkte Kunststoffe (GFK, CFK), alle Kunststoffe (PVC, PA, PE)	Turning (rough)	Vordrehen	80-1000	1,0-5,0	0,1-0,4
		Turning (finish)	Fertigdrehen	80-1500	0,1-2,0	0,05-0,3
		Milling	Fräsen	200-1000	0,1-5,0	0,1-0,3
Wood composite	Holzverbundstoffe	Turning (finish)	Fertigdrehen	2000-5000		0,05-1,0
		Milling	Fräsen	2000-5000		0,05-1,0



* Feedrate for milling-applications = mm/tooth * Vorschubwerte beim Fräsen = mm/Zahn

**Further Dimension, size and radius on demand.
Weitere Abmessungen, Größen und Radien auf Anfrage.**

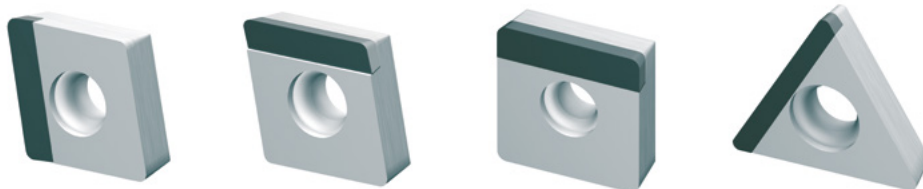
**The PCD insert are also available fully edge tipped or with chipbreaker. (On demand)
Die PKD Platten sind auch leistenbestückt oder mit Spanleitstufe erhältlich. (Auf Anfrage)**



**Recommend cutting data for PCD/CVD-D-tools with chipbreaker MED and ROF.
Schnittdatenempfehlung für PKD/CVD-D-Werkzeuge mit Spanleitstufe MED und ROF.**

MED	for fine- medium cutting für feine - mittlere Bearbeitung	Ø	f (mm/U)	ap max (mm)	
		0,2	0,04 - 0,1	0,05 - 0,6	
ROF	for roughing für Schrapp-Bearbeitung	Ø	f (mm/U)	ap max (mm)	
		0,4	0,1 - 0,25	0,4 - 2,0	
		0,8	0,15 - 0,35	0,6 - 3,0	

This is approximate cutting data. The application should be started in the midrange of recommended cutting conditions. Later, depending on the chip form and surface quality the cutting speeds can be optimised to achieve the best performance.

Die angegebenen Werte stellen nur ungefähre Richtwerte dar! Die Bearbeitung sollte mit dem Mittelwert der empfohlenen Schnittwerte begonnen werden, danach folgend können (entsprechend der Spanform und Oberflächengüte) die Schnittwerte verändert werden, um die Bearbeitung zu optimieren.

Face Milling Tools · Planfräser

Kr:45°



FMA01 N



Fine pitch
Enge Teilung

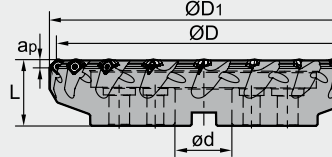
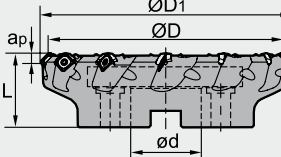
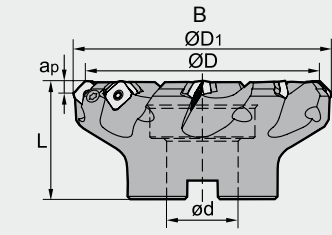
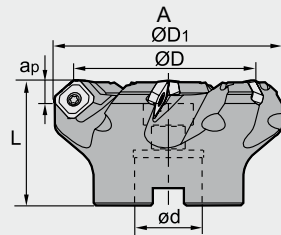

Specification of tools · Werkzeug Beschreibung

Type Typ	Stock Lager	Dimension (mm) Abmessung							No. of teeth Zähne	Coupling Aufnahme	Weight Gewicht (kg)
		R	L	Ø D	Ø D ₁	Ø D	L	ap _{max}			
FMA01 -050-A22-SE12-04	● ○			50	61	22	40	6	4	A	0.3
-050-A22-SE12-04C	● ○			50	61	22	40	6	4	A	0.3
-063-A22-SE12-05	● ○			63	74	22	40	6	5	A	0.5
-063-A22-SE12-05C	● ○			63	74	22	40	6	5	A	0.5
-063-A22-SE12-06C	○ ○			63	74	22	40	6	6	A	1.2
-080-A27-SE12-06	● ○			80	91	27	50	6	6	A	1.2
-080-A27-SE12-06C	● ●			80	91	27	50	6	6	A	1.2
-100-B32-SE12-07	● ○			100	107	32	50	6	7	B	1.2
-100-B32-SE12-07C	● ○			100	107	32	50	6	7	B	1.2
-100-B32-SE12-09L	○ ○			100	107	32	50	6	9	B	4.3
-125-B40-SE12-08	● ●			125	136	40	63	6	8	B	2.6
-125-B40-SE12-08C	○ ○			125	136	40	63	6	8	B	2.6
-160-B40-SE12-10	● ●			160	170	40	63	6	10	B	4.3
-160-B40-SE12-10C	○ ○			160	170	40	63	6	10	B	4.3
-200-C60-SE12-12	● ○			200	210	60	63	6	12	C	7.6
-250-C60-SE12-14	● ○			250	260	60	63	6	14	C	13.5
-315-D60-SE12-18	● ○			315	325	60	70	6	18	D	20.8

● Ex stock / ab Lager ○ On demand / auf Anfrage

Spare Parts · Ersatzteile

Diameter Durchmesser Ø D	Screw Schraube	Shim Unterlage	Shim screw Unterlagenschraube	Wrench Schlüssel	Wrench Schlüssel	
SE12 Ø50 - Ø100	I60M3.5×10	-	-	WT15IS	-	
SE12 Ø125 - Ø315	I60M3.5×12	S13BS	SM5×7XA	WT15IS	WH35L	

Applicable inserts - Wendeschneidplatten

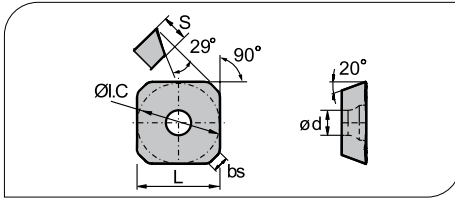

● Ideal Machining Condition / Gute Bearbeitungsbedingungen
⚙️ Normal Machining Condition / Normale Bearbeitungsbedingungen
⚙️ Unfavorable Machining Condition / Ungünstige Bearbeitungsbedingungen

Workpiece Material / Werkstoffe	P	M	K	N	S
Steel / Stahl	●				
Stainless Steel / Rostfreier Stahl					
Cast iron / Gusseisen					
Non-ferrous material / NE-Metalle				⚙️	⚙️
Heat-resistant steel / Warmfester Stahl					

Insert shape / Plattenform	Type / Typ	Dimension (mm) / Abmessung						CVD Coating / CVD Beschicht.	PVD Coating / PVD Beschicht.	Cermet	Carbide uncoat. / unbe. Hartmetall	
		L	I.C	S	d	bs	R				YD101	YD201
	SEET12T3-LH	13.4	13.4	3.97	4.1	2.55					●	●

Recommended cutting data - Empfohlene Schnittdaten

Workpiece material / Werkstückstoff	Hardness HB / Härte	Grade / Sorte	Cutting data / Schnittdaten	
			V (m/min)	f (mm/z)
				-LH
N Al alloy / NE-Metalle	-	YD101	300	0.25 (0.1-0.4)
		YD201	300	0.25 (0.1-0.4)
		YBG101	400-700	0.25 (0.1-0.4)

● Ex stock / ab Lager ○ On demand / auf Anfrage

Face Milling Tools · Planfräser

Kr:45°



FMA02 N



Coarse and differential pitch
Normale und weite Teilung

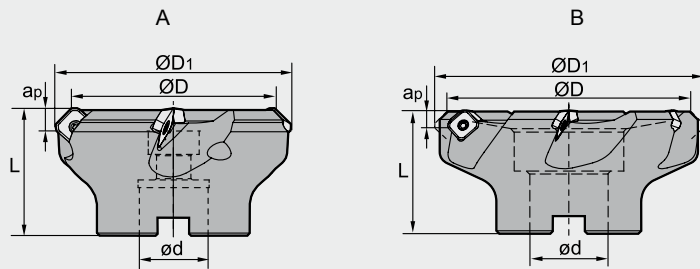

Specification of tools · Werkzeug Beschreibung

Type Typ	Stock Lager		Dimension (mm) Abmessung					No. of teeth Zähne	Coupling Aufnahme	Weight Gewicht (kg)	
	R	L	Ø D	Ø D ₁	Ø D	L	ap _{max}				
FMA02	-050-A22-SE12-03	●	○	50	61	22	40	6	3	A	0.4
	-050-A22-SE12-03C	○	○	50	61	22	40	6	3	A	0.4
	-063-A22-SE12-04	●	○	63	74	22	40	6	4	A	0.6
	-063-A22-SE12-04C	○	○	63	74	22	40	6	4	A	0.6
	-080-A27-SE12-04	●	○	80	91	27	50	6	4	A	1.3
	-080-A27-SE12-04C	○	○	80	91	27	50	6	4	A	1.3
	-100-B32-SE12-05	●	○	100	107	32	50	6	5	B	1.3
	-100-B32-SE12-05C	○	○	100	107	32	50	6	5	B	1.3
	-125-B40-SE12-06	○	○	125	131	40	63	6	6	B	2.6
	-125-B40-SE12-06C	○	○	125	131	40	63	6	6	B	2.6

● Ex Stock / ab Lager ○ On demand / auf Anfrage

Spare Parts · Ersatzteile

Diameter Durchmesser Ø D	Screw Schraube	Wrench Schlüssel	
Ø50-Ø125	 I60M3.5×10	 WT15IS	

Applicable inserts · Wendeschneidplatten

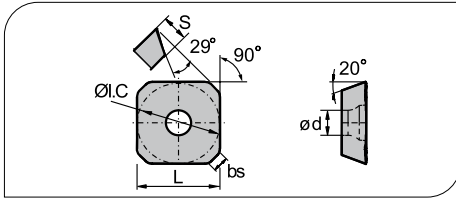

● Ideal Machining Condition / Gute Bearbeitungsbedingungen
 ⚙️ Normal Machining Condition / Normale Bearbeitungsbedingungen
 ⚙️ Unfavorable Machining Condition / Ungünstige Bearbeitungsbedingungen

Workpiece Material / Werkstoffe	P	M	K	N	S
Steel / Stahl					
Stainless Steel / Rostfreier Stahl					
Cast iron / Gusseisen					
Non-ferrous material / NE-Metalle				● ●	● ●
Heat-resistant steel / Warmfester Stahl					

Insert shape / Plattenform	Type · Typ	Dimension (mm) / Abmessung						CVD Coating / CVD Beschicht.			PVD Coating / PVD Beschicht.		Cermet	Carbide uncoat. / unbee. Hartmetall		
		L	I.C.	S	d	bs	R				YBG101	YBG102		YD101	YD201	
	SEET12T3-LH	13.4	13.4	3.97	4.1	2.55					●	○			●	●

Recommended cutting data · Empfohlene Schnittdaten

Workpiece material / Werkstückstoff	Hardness HB / Härte	Grade / Sorte	Cutting data · Schnittdaten		
			V (m/min)	f (mm/z)	
				-LH	
N	Al alloy / NE-Metalle	YD101	300	0.25 (0.1-0.4)	
		YD201	300	0.25 (0.1-0.4)	
		YBG101	400-700	0.25 (0.1-0.4)	
		YBG102	400-700	0.2 (0.08-0.4)	

● Ex Stock / ab Lager
 ○ On demand / auf Anfrage

Kr:90°



Face Milling Tools · Planfräser

FMP02 N

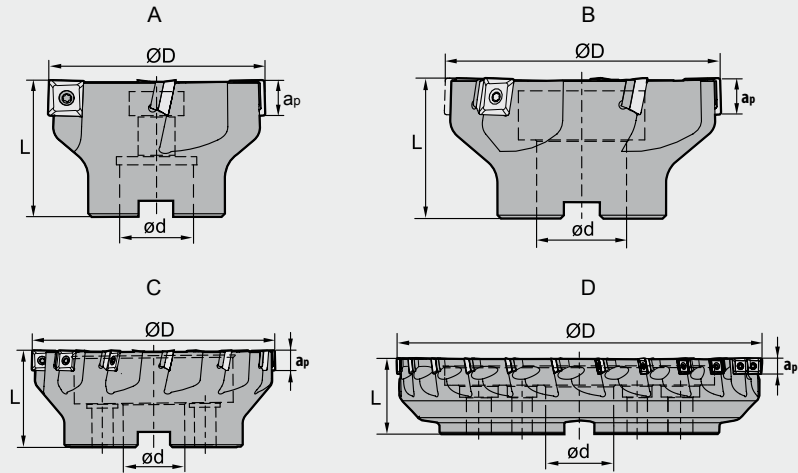
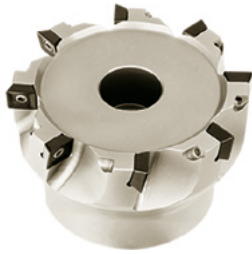

Specification of tools · Werkzeug Beschreibung

Type Typ	Stock Lager	Dimension (mm) Abmessung				No. of teeth Zähne	Coupling Aufnahme	Weight Gewicht (kg)
		Ø D	Ø D	L	apmax			
FMP02 -050-A22-SE12-03	○	50	22	40	10.8	3	A	0.3
-050-A22-SE12-03C	○	50	22	40	10.8	3	A	0.3
-063-A22-SE12-04	○	63	22	40	10.8	4	A	0.4
-063-A22-SE12-04C	○	63	22	40	10.8	4	A	0.4
-080-A27-SE12-04	●	80	27	50	10.8	4	A	0.9
-080-A27-SE12-04C	○	80	27	50	10.8	4	A	0.9
-100-B32-SE12-05	●	100	32	50	10.8	5	B	1.2
-100-B32-SE12-05C	○	100	32	50	10.8	5	B	1.2
-125-B40-SE12-06	○	125	40	63	10.8	6	B	3.1
-125-B40-SE12-06C	○	125	40	63	10.8	6	B	3.1
-160-C40-SE12-08	●	160	40	63	10.8	8	C	4.1
-250-C60-SE12-12	○	250	60	63	10.8	12	C	11.1
-050-A22-SE12-04	●	50	22	40	10.8	4	A	0.3
-050-A22-SE12-04C	●	50	22	40	10.8	4	A	0.3
-063-A22-SE12-05	●	63	22	40	10.8	5	A	0.4
-063-A22-SE12-05C	●	63	22	40	10.8	5	A	0.4
-080-A27-SE12-06	●	80	27	50	10.8	6	A	0.8
-080-A27-SE12-06C	●	80	27	50	10.8	6	A	0.8
-100-B32-SE12-07	●	100	32	50	10.8	7	B	1.2
-100-B32-SE12-07C	○	100	32	50	10.8	7	B	1.2
-125-B40-SE12-08	●	125	40	63	10.8	8	B	3.0
-125-B40-SE12-08C	○	125	40	63	10.8	8	B	3.0
-160-C40-SE12-12	●	160	40	63	10.8	12	C	3.9
-050-A22-SE12-05	●	50	22	40	10.8	5	A	0.2
-050-A22-SE12-05C	○	50	22	40	10.8	5	A	0.2
-063-A22-SE12-06	●	63	22	40	10.8	6	A	0.4
-063-A22-SE12-06C	○	63	22	40	10.8	6	A	0.4
-080-A27-SE12-08	●	80	27	50	10.8	8	A	0.8
-080-A27-SE12-08C	○	80	27	50	10.8	8	A	0.8
-100-B32-SE12-10	●	100	32	50	10.8	10	B	1.2
-100-B32-SE12-10C	○	100	32	50	10.8	10	B	1.2
-125-B40-SE12-12	●	125	40	63	10.8	12	B	2.9
-125-B40-SE12-12C	○	125	40	63	10.8	12	B	2.9
-200-C60-SE12-16	●	200	60	63	10.8	16	C	6.1
-250-C60-SE12-18	●	250	60	63	10.8	18	C	10.9
-315-D60-SE12-24	○	315	60	63	10.8	24	D	21.6

● Ex Stock / ab Lager ○ On demand / auf Anfrage

Spare Parts - Ersatzteile

Diameter Durchmesser Ø D	Insert Platte	Shim Unterlage	Screw Schraube	Screw Unterlage Schraube	Wrench Schlüssel	Wrench Schlüssel	
Ø50	SE12	-	I60M3.5×10	-	WT15IS	-	
Ø63 ~ Ø315		S12BSX	I60M3.5×12	SM5×7XA	WT15IS	WH35L	

Applicable inserts - Wendschneidplatten

● Ideal Machining Condition / Gute Bearbeitungsbedingungen
● Normal Machining Condition / Normale Bearbeitungsbedingungen
● Unfavorable Machining Condition / Ungünstige Bearbeitungsbedingungen

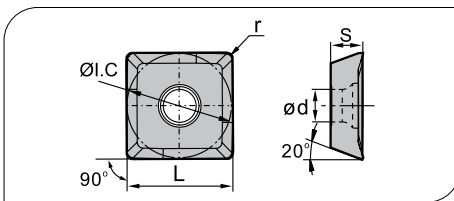

Workpiece Material Werkstoff	Steel / Stahl	Stainless Steel / Rostfreier Stahl	Cast iron / Gusseisen	Non-ferrite material / Ne Metalle	Heat-resistant steel / Warmfester Stahl
P	●	●	●	●	●
M	●	●	●	●	●
K	●	●	●	●	●
N	●	●	●	●	●
S	●	●	●	●	●

Insert shape Plattenform	Type · Typ	Dimension (mm) Abmessung					CVD Coating CVD Beschicht.	PVD Coating PVD Beschicht.		Cermet	Carbide uncoat. unbe. Hartmetall
		L	I.C	S	d	r		YBG101 YBG102	YD101		
	SEET120308-LH	13.308	13.308	4.04	4.1	0.8		● ○			●

● Ex Stock / ab Lager ○ On demand / auf Anfrage

Recommended cutting data - Empfohlene Schnittdaten

Workpiece material Werkstück Material	Hardness HB Härte	Grade Sorte	Cutting data · Schnittdaten	
			Square shoulder milling · Eckfräsen	
			V(m/min)	f(mm/z)
N Al alloy Al-Legierungen	---	YD101	300	0.2 (0.08-0.4)
		YBG101	300	0.2 (0.08-0.4)
		YBG102	400-700	0.2 (0.08-0.4)

Face Milling Tools · Planfräser

Kr:45°



FMA04 N

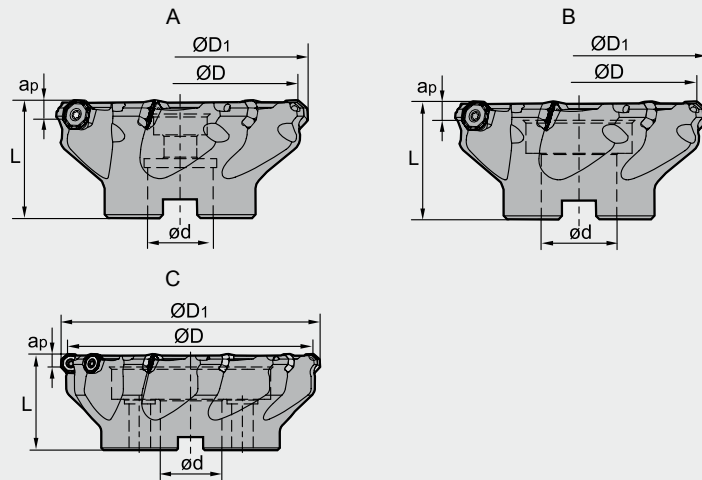
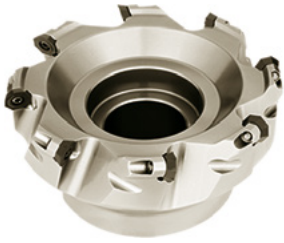



Specification of tools · Werkzeug Beschreibung

Type Typ	Stock Lager		Dimension (mm) Abmessung					No. of teeth Zähne	Coupling Aufnahme	Weight Gewicht (kg)
	R	L	Ø D	Ø D ₁	Ø d	L	a _p max			
FMA04 -050-A22-OF05-04	●	○	50	56	22	40	3.5	4	A	0.3
-050-A22-OF05-04C	○	○	50	56	22	40	3.5	4	A	0.3
-050-A22-OF05-05	●	○	50	56	22	40	3.5	5	A	0.4
-050-A22-OF05-05C	○	○	50	56	22	40	3.5	5	A	0.4
-063-A22-OF05-05	●	○	63	69	22	40	3.5	5	A	0.5
-063-A22-OF05-05C	○	○	63	69	22	40	3.5	5	A	0.5
-080-A27-OF05-06	●	○	80	86	27	50	3.5	6	A	0.8
-080-A27-OF05-06C	○	○	80	86	27	50	3.5	6	A	0.8
-100-B32-OF05-07	●	○	100	106	32	50	3.5	7	B	1.2
-100-B32-OF05-07C	○	○	100	106	32	50	3.5	7	B	1.2
-125-B40-OF05-08	●	○	125	130	40	63	3.5	8	B	2.7
-125-B40-OF05-08C	○	○	125	130	40	63	3.5	8	B	2.7
-160-B40-OF05-10	○	○	160	165	40	63	3.5	10	B	5.1

● Ex Stock / ab Lager ○ On demand / auf Anfrage

Spare Parts · Ersatzteile

Diameter Durchmesser Ø D	Screw Schraube	Wrench Schlüssel	
			
Ø50-Ø63	I60M4×8.4	WT15IS	
Ø80-Ø160	I60M4×10		

Milling · Fräsen

Indexable Milling Tools · Wendeplattenfräser

Face Milling Tools · Planfräser



FMR03 **P** **M** **K**

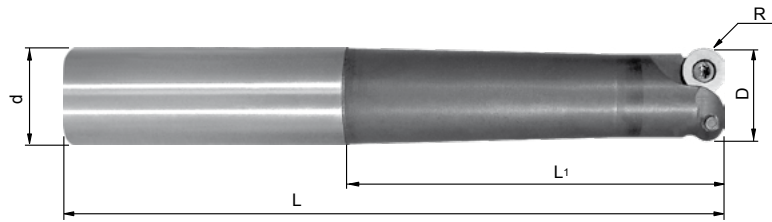

Type Typ	*	Stock Lager	Dimension (mm) Abmessung						No. of teeth Zähne
			Ø D	Ø d	L	L ₁	R	a _{pmax}	
FMR03 -015-G16-XS RD0702-02		●	15	16	88	40	3.5	3.5	2
-015-G16-XS RD0702-02C	*	○	15	16	88	40	3.5	3.5	2
-015-G16-S RD0702-02		●	15	16	108	60	3.5	3.5	2
-015-G16-S RD0702-02C	*	○	15	16	108	60	3.5	3.5	2
-015-G20-M RD0702-02		●	15	20	130	80	3.5	3.5	2
-015-G20-M RD0702-02C	*	○	15	20	130	80	3.5	3.5	2
-015-G20-L RD0702-02		○	15	20	150	100	3.5	3.5	2
-015-G20-L RD0702-02C	*	○	15	20	150	100	3.5	3.5	2
-015-G25-XL RD0702-02		●	15	25	120	176	3.5	3.5	2
-015-G25-XL RD0702-02C	*	○	15	25	120	176	3.5	3.5	2
-020-G20-XS RD1003-02		○	20	20	90	40	5	5	2
-020-G20-XS RD1003-02C	*	○	20	20	90	40	5	5	2
-020-G20-S RD1003-02		●	20	20	110	60	5	5	2
-020-G20-S RD1003-02C	*	○	20	20	110	60	5	5	2
-020-G25-M RD1003-02		●	20	25	136	80	5	5	2
-020-G25-M RD1003-02C	*	○	20	25	136	80	5	5	2
-020-G25-L RD1003-02		●	20	25	156	100	5	5	2
-020-G25-L RD1003-02C	*	○	20	25	156	100	5	5	2
-020-G25-XL RD1003-02		●	20	25	176	120	5	5	2
-020-G25-XL RD1003-02C	*	○	20	25	176	120	5	5	2

■ Spare Parts · Ersatzteile

Type Typ	Screw Schraube	Wrench Schlüssel	
FMR03**RD0702	 I60M2,5 x 5,0	 WT07P	
FMR03**RD1003	 I60M3,5 x 7,7	 WT15P	

● Ex Stock / ab Lager ○ On demand / auf Anfrage * With internal cooling · Mit Innenkühlung

Face Milling Tools · Planfräser



FMR04 P M K

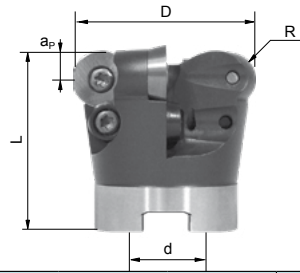

Type Typ	Stock Lager	Dimension (mm) Abmessung					No. of teeth Zähne
		Ø D	Ø d	L	R	a _P max	
FMR04							
042-A16-RD1003-06	●	42	16	44	5	5	6
042-A16-RD1003-06C	* ●	42	16	44	5	5	6
052-A22-RD1003-06	●	52	22	50	5	5	6
052-A22-RD1003-07	●	52	22	50	5	5	7
052-A22-RD1003-07C	* ●	52	22	50	5	5	7
042-A16-RD12T3-05	●	42	16	42	6	6	5
042-A16-RD12T3-05C	* ●	42	16	42	6	6	5
052-A22-RD12T3-05	●	52	22	50	6	6	5
052-A22-RD12T3-05C	* ●	52	22	50	6	6	5
066-A27-RD12T3-06	●	66	27	50	6	6	6
066-A27-RD12T3-06C	* ●	66	27	50	6	6	6
080-A27-RD12T3-07	●	80	27	50	6	6	7
080-A27-RD12T3-07C	* ●	80	27	50	6	6	7

■ Spare Parts · Ersatzteile

Type Typ	Screw Schraube	Wrench Schlüssel
		
FMR04**RD1003	I60M3,5 x 7,7	WT15P
FMR04**RD12T3	I60M3,5 x 7,7	WT15P
FMR04**RD1604	I60M4,5 x 1,0	WT20T

Milling · Fräsen

Indexable Milling Tools · Wendeplattenfräser

QCH - RD

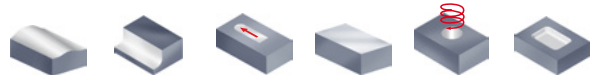

P M K

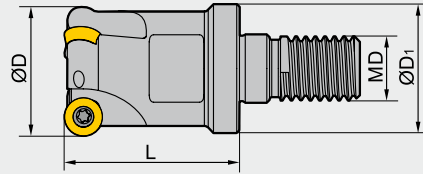
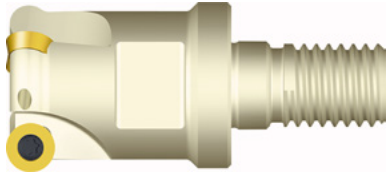

Type	Stock	Dimensions (mm)				Insert	No. of teeth (Z)	Weight (kg)	Coolant	
		ØD	ØD ₁	L	MD					
QCH	-15-RDKW0702-M8-02	○	15	12.5	23	8	RDKW0702MO	2	-	Internal cooling
	-15-RDKW0702-M8-03	○	15	12.5	23	8		3	-	
	-20-RDKW0702-M10-04	●	20	18	30	10		4	-	
	-25-RDKW0702-M12-05	●	25	21	35	12	RDKW1003MO	5	-	
	-20-RDKW1003-M10-02	●	20	18	30	10		2	-	
	-25-RDKW1003-M12-02	●	25	21	35	12		2	-	
	-25-RDKW1003-M12-03	●	25	21	35	12		3	-	
	-30-RDKW1003-M16-04	●	30	29	43	16		4	-	
	-35-RDKW1003-M16-04	●	35	29	43	16		4	-	
	-42-RDKW1003-M16-05	●	42	29	43	16	5	-		
	-24-RDKW12T3-M12-02	●	24	21	35	12	RDKW12T3MO	2	-	
	-35-RDKW12T3-M16-03	●	35	29	43	16		3	-	
-42-RDKW12T3-M16-04	●	42	29	43	16	4		-		

■ Spare parts · Ersatzteile

Insert Durchmesser Ø D	Insert Screw Schraube	Wrench Schlüssel		
RDKW0702MO	I60M2.2×5.5	WT07IP	--	
RDKW1003MO	I60M3.5×7.7	WT15	--	
RDKW12T3MO	I60M3.5×7.7	WT15	--	

● Ex Stock / ab Lager ○ On demand / auf Anfrage

Milling - Fräsen

Indexable Milling Tools - Wendeplattenfräser

Applicable inserts · Wendeschneidplatten

● Ideal Machining Condition / Gute Bearbeitungsbedingungen
 ● Normal Machining Condition / Normale Bearbeitungsbedingungen
 ● Unfavorable Machining Condition / Ungünstige Bearbeitungsbedingungen

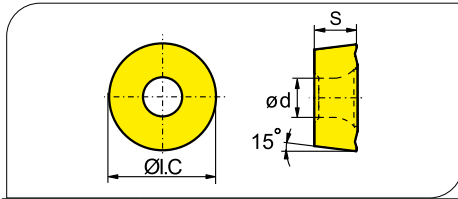

Workpiece Material / Werkstoffe	Steel / Stahl	Stainless Steel / Rostfreier Stahl	Cast iron / Gusseisen	Non-ferrite material / Ne Metalle	Heat-resistant steel / Warmfester Stahl
P	●	●	●	●	●
M	●	●	●	●	●
K	●	●	●	●	●
N	●	●	●	●	●
S	●	●	●	●	●

Insert shape / Plattenform	Type / Typ	Dimension (mm) / Abmessung			CVD Coating / CVD Beschicht.					PVD Coating / PVD Beschicht.					Cermets / Cermet	Carbide uncoat. / unbe. Hartmetall											
		I.C	S	d	YBC302	YBC301	YBC401	YBM253	YBM251	YBM351	YBD152	YBD252	YBG102	YB9320			YBG205	YBG202	YBG212	YBG302	YBG152	YBG252	YNG151	YNG151C	YC30S	YD101	YD201
	RDHT0702MO-LH	7.0	2.38	2.7																						●	
	RDHT1003MO-LH	10.0	3.18	3.9																							●
	RDHT12T3MO-LH	12.0	3.97	3.9																							●

Milling · Fräsen

Indexable Milling Tools · Wendepplattenfräser

Square shoulder milling tools · Eckfräser

Kr:90°

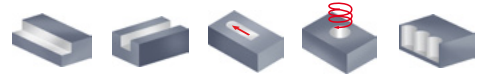

EMP01 N

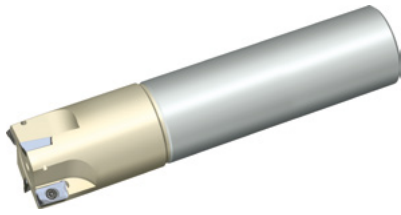

Straight shank

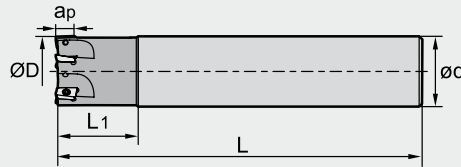



Specification of tools · Werkzeug Beschreibung

	Type Typ	Stock Lager	Dimensions (mm) Abmessungen					No. of teeth Zähne	Weight Gewicht (kg)
			Ø D	Ø d	L	L ₁	ap _{max}		
Straight shank Zylinder- schaft	EMP01 012-G16-AP11-01	●	12	16	85	25	10.5	1	0.1
	012-G16-AP11-01C	○	12	16	85	25	10.5	1	0.1
	016-G16-AP11-02	●	16	16	90	25	10.5	2	0.1
	016-G16-AP11-02C	○	16	16	90	25	10.5	2	0.1
	020-G20-AP11-02	●	20	20	100	30	10.5	2	0.2
	020-G20-AP11-02C	●	20	20	100	30	10.5	2	0.2
	020-G20-AP11-03	●	20	20	100	30	10.5	3	0.2
	020-G20-AP11-03C	●	20	20	100	30	10.5	3	0.2
	025-G25-AP11-03	●	25	25	115	35	10.5	3	0.4
	025-G25-AP11-03C	○	25	25	115	35	10.5	3	0.4
	025-G25-AP11-04	●	25	25	115	35	10.5	4	0.4
	025-G25-AP11-04C	○	25	25	115	35	10.5	4	0.4
	032-G32-AP11-04	●	32	32	125	40	10.5	4	0.7
	032-G32-AP11-04C	○	32	32	125	40	10.5	4	0.7
Straight shank Zylinder- schaft	EMP01 025-G25-AP16-02	●	25	25	115	35	15.5	2	0.4
	025-G25-AP16-02C	●	25	25	115	35	15.5	2	0.4
	032-G32-AP16-03	●	32	32	125	40	15.5	3	0.7
	032-G32-AP16-03C	○	32	32	125	40	15.5	3	0.7
	040-G32-AP16-03	●	40	32	130	42	15.5	3	0.7
	040-G32-AP16-03C	●	40	32	130	42	15.5	3	0.7
	040-G32-AP16-04	●	40	32	130	42	15.5	4	0.8
	040-G32-AP16-04C	○	40	32	130	42	15.5	4	0.8
	050-G32-AP16-05	●	50	32	135	45	15.5	5	1.0
	050-G32-AP16-05C	○	50	32	135	45	15.5	5	1.0
063-G32-AP16-06	●	63	32	135	45	15.5	6	1.4	
063-G32-AP16-06C	○	63	32	135	45	15.5	6	1.4	

● Ex Stock / ab Lager ○ On demand / auf Anfrage

Spare Parts · Ersatzteile

Diameter Durchmesser Ø D	Insert Wendepplatte	Screw Schraube	Wrench Schlüssel	
				
Ø12-Ø32	AP11	I60M2.5×6.5T	WT08IP	--
Ø25-Ø63	AP16	I60M4×8.4	--	WT15IS

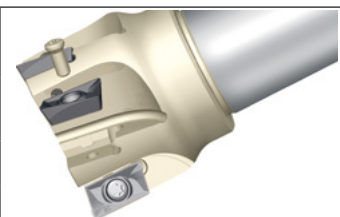

Square shoulder milling tools · Eckfräser

Kr:90°



EMP02 N

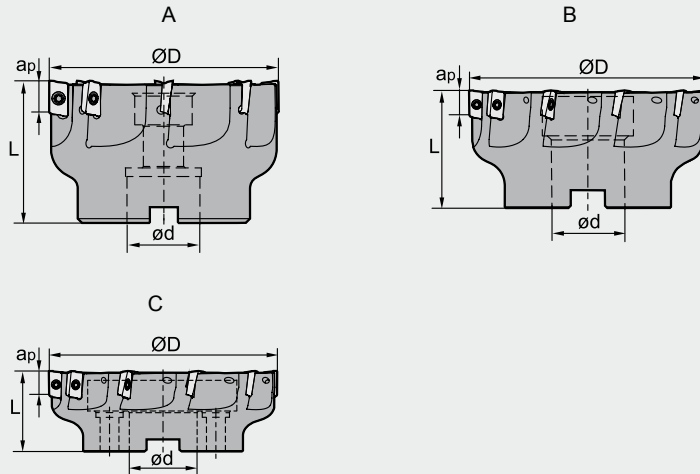
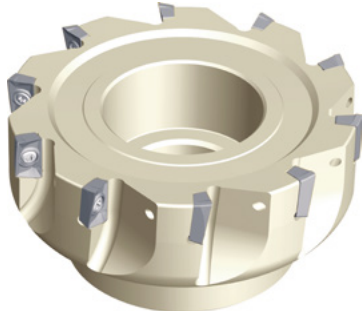

Specification of tools · Werkzeug Beschreibung

Type Typ	Stock Lager	Dimensions (mm) Abmessungen				No. of teeth Zähne	Coupling Aufnahme	Weight Gewicht (kg)
		Ø D	Ø d	L	apmax			
EMP02	050-A22-AP11-06	●	50	22	40	11	A	0.3
	050-A22-AP11-06C	●	50	22	40	11	A	0.3
	063-A22-AP11-08	●	63	22	40	11	A	0.6
	063-A22-AP11-08C	●	63	22	40	11	A	0.6
	080-A27-AP11-08	●	80	27	50	11	A	1.2
	080-A27-AP11-08C	●	80	27	50	11	A	1.2
	100-B32-AP11-10	●	100	32	50	11	B	1.7
	100-B32-AP11-10C	○	100	32	50	11	B	1.7
EMP02	050-A22-AP16-05	●	50	22	40	15.5	A	0.3
	050-A22-AP16-05C	●	50	22	40	15.5	A	0.3
	063-A22-AP16-06	●	63	22	40	15.5	A	0.5
	063-A22-AP16-06C	●	63	22	40	15.5	A	0.5
	080-A27-AP16-07	●	80	27	50	15.5	A	1.1
	080-A27-AP16-07C	●	80	27	50	15.5	A	1.1
	100-B32-AP16-08	●	100	32	50	15.5	B	1.6
	100-B32-AP16-08C	●	100	32	50	15.5	B	1.6
	125-B40-AP16-10	●	125	40	63	15.5	B	3.2
	125-B40-AP16-10C	○	125	40	63	15.5	B	3.2
	160-B40-AP16-10	○	160	40	63	15.5	B	6.3
	160-B40-AP16-10C	○	160	40	63	15.5	B	6.3
	200-C60-AP16-12	○	200	60	63	15.5	C	8.1
	250-C60-AP16-12	○	250	60	63	15.5	C	11.2

● Ex Stock / ab Lager ○ On demand / auf Anfrage

Spare Parts · Ersatzteile

Diameter Durchmesser Ø D	Insert Wendeplatte	Screw Schraube	Wrench Schlüssel	
Ø50-Ø250	AP11	I60M2.5×6.5T	WT08IS	
Ø50-Ø250	AP16	I60M2.5×6.0A	WT15IS	

High cutting data change the screw!
Bei höheren Schnittwerten Schraube wechseln!

Milling · Fräsen

Indexable Milling Tools · Wendeplattenfräser

Square shoulder milling tools · Eckfräser

Kr:90°



EMPO3 N

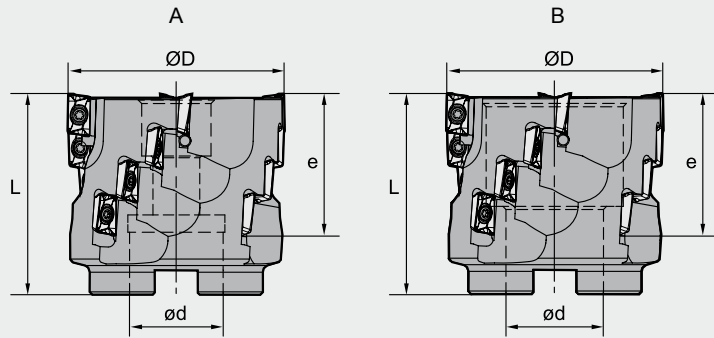
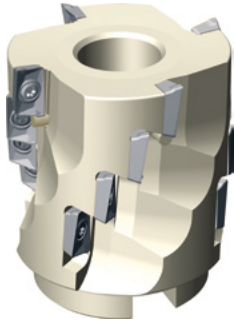



Specification of tools · Werkzeug Beschreibung

Type Typ	Stock Lager	Dimensions (mm) Abmessungen				Flute number Zahn- reihen z	No. of inserts WSP Anzahl	Coupling Aufnahme	Weight Gewicht (kg)
		Ø D	Ø d	L	e				
EMPO3 -050-A22-AP11-04	●	50	22	58	39	4	16	A	0.5
-050-A22-AP11-04C	○	50	22	58	39	4	16	A	0.5
-063-A27-AP11-04	●	63	27	58	39	4	16	A	0.9
-063-A27-AP11-04C	○	63	27	58	39	4	16	A	0.9
-080-B32-AP11-05	●	80	32	63	39	5	20	B	1.3
-080-B32-AP11-05C	○	80	32	63	39	5	20	B	1.3
-100-B40-AP11-06	●	100	40	63	39	6	24	B	2.0
-100-B40-AP11-06C	○	100	40	63	39	6	24	B	2.0

● Ex Stock / ab Lager ○ On demand / auf Anfrage

Spare Parts · Ersatzteile

Diameter Durchmesser Ø D	Insert Wendeplatte	Screw Schraube	Wrench Schlüssel
			
Ø50-Ø100	AP11	I60M2.5×6.5T	WT08IS
		I60M2.5×6.0A	High cutting data change the screw! <i>Bei höheren Schnittwerten Schraube wechseln!</i>

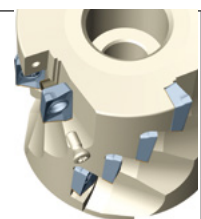

Square shoulder milling tools · Eckfräser

Kr:90°



EMP04 N

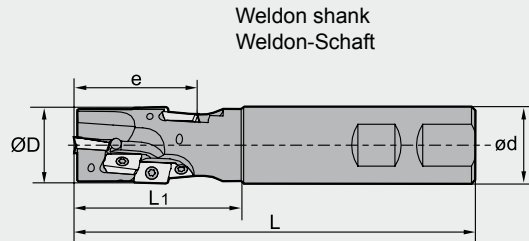
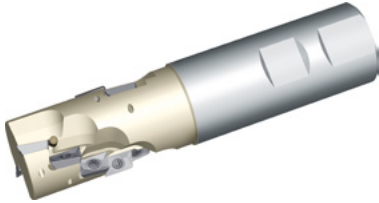

Specification of tools · Werkzeug Beschreibung

	Type Typ	Stock Lager	Dimensions (mm) Abmessungen					Flute number Zahn- reihen Z	No. of inserts WSP Anzahl	Weight Gewicht (kg)
			Ø D	Ø d	L	L ₁	e			
EMP04	-020-XP20-AP11-01	●	20	20	120	45	29.4	1	3	0.3
	-025-XP25-AP11-02	●	25	25	130	55	38.9	2	8	0.4
	-032-XP32-AP11-02	●	32	32	140	65	48.5	2	10	0.7
	-040-XP40-AP11-02	●	40	40	150	75	58.0	2	14	1.3

● Ex Stock / ab Lager ○ On demand / auf Anfrage

Spare Parts · Ersatzteile

Diameter Durchmesser Ø D	Screw Schraube	Wrench Schlüssel	
	Ø20-Ø40	 I60M2.5×6.5T	

Milling - Fräsen

Indexable Milling Tools - Wendepplattenfräser

Applicable inserts ·
Wendeschneidplatten

● Ideal Machining Condition / Gute Bearbeitungsbedingungen
 ● Normal Machining Condition / Normale Bearbeitungsbedingungen
 ● Unfavorable Machining Condition / Ungünstige Bearbeitungsbedingungen

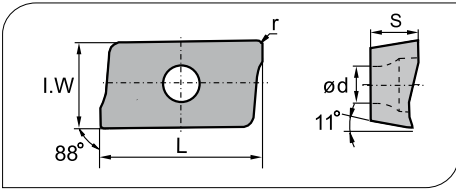

Workpiece Material / Werkstoff	Material	Condition
P	Steel / Stahl	●
M	Stainless Steel / Rostfreier Stahl	●
K	Cast iron / Gusseisen	●
N	Non-ferrite material / Ne Metalle	●
S	Heat-resistant steel / Warmfester Stahl	●

Insert shape / Plattenform	Type / Typ	Dimensions (mm) / Abmessungen					CVD Coating / CVD Beschicht.		PVD Coating / PVD Beschicht.		Cermet	uncoated unbe. Hartmetall	
		L	I.W	S	d	r						YD101	YD201
	APKT11T304-ALH	12.24	6.5	3.6	2.8	0.4	●					●	●
	APKT11T308-ALH	12.24	6.5	3.6	2.8	0.8	●					●	●
	APKT160408-ALH	17.877	9.33	5.76	4.4	0.8	●					●	●

● Ex Stock / ab Lager ○ On demand / auf Anfrage

Recommended cutting data · Empfohlene Schnittdaten

Workpiece material / Werkstück Material	Hardness HB / Härte	Grade / Sorte	Cutting data · Schnittdaten	
			Square shoulder milling · Eckfräsen	
			V(m/min)	f(mm/z)
N Al alloy / Alu-Legierungen	---	YD101	300	0.2 (0.08-0.4)
		YD201	300	0.2 (0.08-0.4)
		YBG101	400-700	0.2 (0.08-0.4)

Applicable inserts · Wendeschneidplatten

● Ideal Machining Condition / Gute Bearbeitungsbedingungen
 ● Normal Machining Condition / Normale Bearbeitungsbedingungen
 ● Unfavorable Machining Condition / Ungünstige Bearbeitungsbedingungen

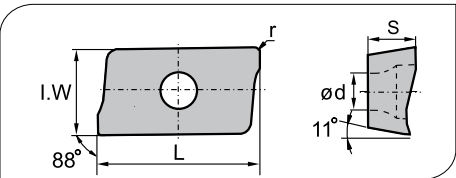

Workpiece Material / Werkstoff	Material	Condition
P	Steel / Stahl	●
M	Stainless Steel / Rostfreier Stahl	●
K	Cast iron / Gusseisen	●
N	Non-ferrite material / Ne Metalle	●
S	Heat-resistant steel / Warmfester Stahl	●

Insert shape / Plattenform	Type · Typ	Dimensions (mm) / Abmessungen					CVD Coating / CVD Beschicht.		PVD Coating / PVD Beschicht.		Cermet	Carbide uncoat. unbe. Hartmetall	
		L	I.W	S	d	r						YD101	YD201
	APKT11T304-LH	12.24	6.5	3.6	2.8	0.4						○	○
	APKT11T308-LH	12.24	6.5	3.6	2.8	0.8						○	○
	APKT160408-LH	17.877	9.33	5.76	4.4	0.8						○	○

● Ex Stock / ab Lager ○ On demand / auf Anfrage

Recommended cutting data · Empfohlene Schnittdaten

Workpiece material / Werkstück Material	Hardness HB / Härte	Grade / Sorte	Cutting data · Schnittdaten	
			Square shoulder milling · Eckfräsen	
			V(m/min)	f(mm/z)
N Al alloy / Alu-Legierungen	---	YD101	300	0.2 (0.08-0.4)
		YD201	300	0.2 (0.08-0.4)

High cutting data change the screw! - Bei höheren Schnittwerten Schraube wechseln!

Square shoulder milling tools · Eckfräser

Kr:90°





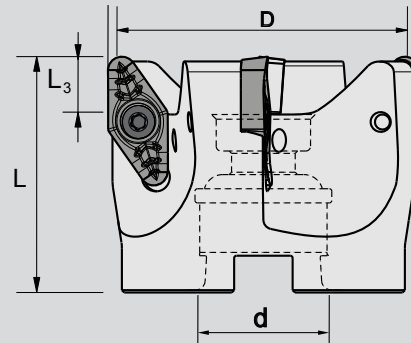

EMPX N



Specification of tools · Werkzeug Beschreibung

Type Typ	Stock Lager	Dimensions (mm) Abmessungen				No. of teeth Zähne	Coupling Aufnahme	Weight Gewicht (kg)
		Ø D	Ø d	L	L ₃			
EMPX 042-A16-VC22-03C	○	42	16	55	15	3	A	0,20
052-A22-VC22-03C	○	52	22	55	15	3	A	0,35
066-A27-VC22-04C	○	66	27	56	15	4	A	0,55
080-A27-VC22-04C	○	80	27	56	15	4	A	0,90

Spare parts · Ersatzteile

Diameter Durchmesser Ø D	No of teeth Zähne (Z)	Clamp Screw Schraube	Wrench Schlüssel
42-52	3	 I60M4.5*10	 WT20IP
66-80	4	 I60M4.5*10	 WT20IP

Square shoulder milling tools · Eckfräser

Kr:90°



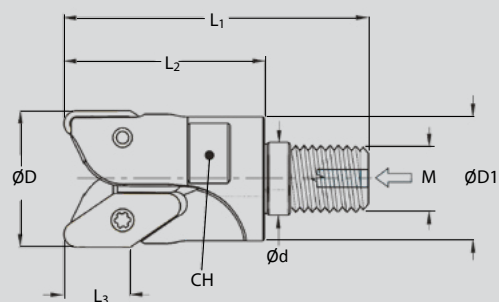

QCH



Specification of tools · Werkzeug Beschreibung

Type Typ	Stock Lager	Dimensions (mm) Abmessungen				L ₁	L ₃	No. of teeth Zähne (Z)	Weight Gewicht (kg)
		ØD	Ød	L ₂	M				
QCH 32-VC22-M16-02	●	32	17	47	16	71	15	2	0,15
42-VC22-M16-03	●	42	17	47	16	71	15	3	0,20

Spare parts · Ersatzteile

Clamp screw Schraube	Wrench Schlüssel
 I60M4.5*10	 WT20IP

Milling - Fräsen

Indexable Milling Tools - Wendeplattenfräser

VC** Positive Insert/ Positive WSP

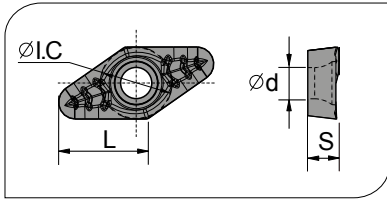

● Ideal Machining Condition / Gute Bearbeitungsbedingungen
● Normal Machining Condition / Normale Bearbeitungsbedingungen
● Unfavorable Machining Condition / Ungünstige Bearbeitungsbedingungen

Workpiece Material / Werkstoffe	Steel / Stahl	Stainless Steel / Rostfreier Stahl	Cast iron / Gusseisen	Non-ferrite material / Ne Metalle	Heat-resistant steel / Warmfester Stahl
P	●	●	●	●	●
M	●	●	●	●	●
K	●	●	●	●	●
N	●	●	●	●	●
S	●	●	●	●	●

Insert Shape / Plattenform	Type / Typ	Dimension / Abmessungen						PVD Coated Carbide / PVD Beschichtet		Uncoated Carbide / Unbesch. Hartmetall		Diamant-coat. Carbide / Diamantbesch. Hartmetall	PCD brazed / PKD bestückt
		L	I.C	S	d	r	ap max	YBG101	YBG102	YD101	YD201	YCD110	YCD421
	VCGX220530-LC	22	12,7	5,56	5,5	3	7	●	○	●	●	○	
	VCGX220530-LH	22	12,7	5,56	5,5	3	7	○		●	○	○	
	VCGX220530-1	22	12,7	5,56	5,5	3	5						●

Recommended cutting data VCGX - Empfohlene Schnittdaten VCGX

Workpiece material / Werkstück Material	Grade / Sorte	Vc(m/min)	fz (mm/t)
Aluminium Legierung Si<12% Aluminium Alloys Si<12%	YD101, YD201, YBG101, YCD421	800-3500	0,05-0,3
hochsiliziumhaltiges Aluminium >12% Aluminium with silicon >12%	YD101, YD201, YBG101, YBG102, YCD421	400-1000	0,05-0,3
Kupferlegierungen Copper alloys	YD101, YD201 YBG102, YCD421	700-1200	0,1-0,3
Kunststoff, Graphit, CFK/GFK Plastic, graphite, CFK/GFK	YBG102, YCD110, YCD421	200-1000	0,1-0,3
Epoxidharz Blockmaterial Epoxy resin	YCD110, YCD421	900-1500	0,18-0,5
Holzverbundstoffe Wood composite	YBG102, YCD110, YCD421	2000-5000	0,05-1,0

Ramp milling, helical interpolation milling Tauchfräsen, Spiral Interpolationsfräsen

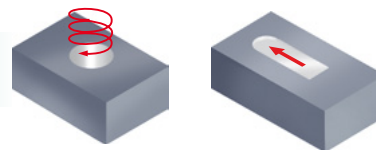

Recommended cutting data - Empfohlene Schnittdaten

Tool / Werkzeug	Diameter / Ø D (mm)	Ramp milling / Tauchfräsen	Helical interpolation milling / Spiral-Interpolationsfräsen	
		Max. cutting depth / Schnitttiefe ap(mm)	Min. diameter / Durchmesser Ø D1(mm)	Max. pitch / Steigung (mm)
EMPX	42	5	78	5
	52	5	98	5
	66	5	126	5
	80	-	-	-
QCH	32	5	58	5
	42	5	78	5

EMP13 $Kr:90^\circ$

Achieving 90° with high quality Square Shoulder Milling Tools

Erreichen Sie 90° mit der neuen Eckfräuserserie

The PVD coating of the tools leads to a longer tool life.

Eine PVD-Beschichtung auf dem Fräser erzielt eine höhere Lebensdauer der Trägerwerkzeuge.

Extra thick inserts with a positive soft cutting geometry reduces the cutting resistance and improves the wear resistance at the same time.

Extra dicke Wendeschneidplatte mit einer positiv weich schneidenden Geometrie reduziert den Schneidwiderstand bei gleichzeitiger Verbesserung der Bruchfestigkeit.

Maximum cutting depth:
Maximale Schnitttiefe:

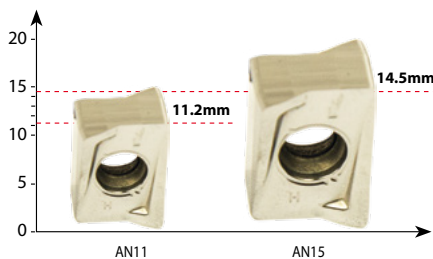

Example

Beispiel

Workpiece Material:
Werkstück Material:

EN AW 5083
Aluminium

Cutting condition cutting data:
Schnittbedingungen:

Vc 840 m/min
n 5410
Ap 3,00 mm
Fz 0,21 mm
Vf 4500 mm/min

Tool:
Werkzeug:

EMP13-050-A22-AN15-04

Inserts:
WSP:

ANGX150608 ALH YD101

Specially designed cutting edges with high precision control can achieve high quality 90° square shoulder milling.

Speziell entwickelte Schneidkanten mit hoher Präzisionskontrolle für qualitativ hochwertige 90° Eckfräser.

The component machined by using EMP13 shows better surface quality and verticality than the similar products from a competitor.

Das Werkstück, das mit EMP13 bearbeitet wurde, weist eine bessere Oberflächengüte und Vertikalität auf als nach der Bearbeitung mit einem ähnlichen Produkt vom Wettbewerber.



Square Shoulder Milling Tools · Eckfräser

Kr:90°



EMP13 N

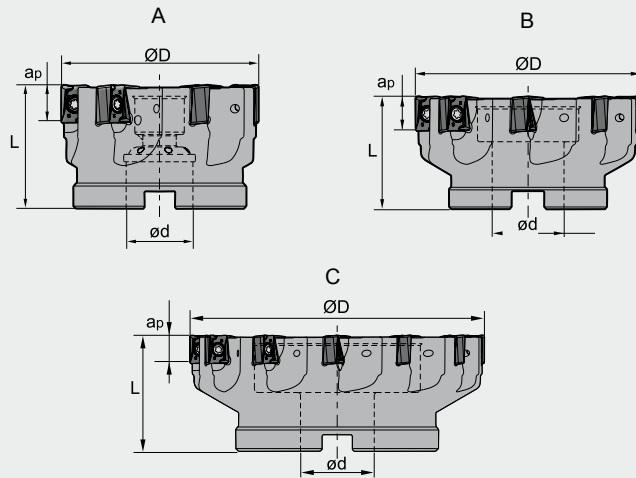

Specification of tools · Werkzeug Beschreibung

Type Typ	*	Stock Lager		Dimension (mm) Abmessung				No. of teeth Zähne	Coupling Aufnahme	Weight Gewicht (kg)	
		R	L	ØD	Ød	L	apmax				
EMP13	-050-A22-AN11-06	*	●		50	22	40	11.2	6	A	0.30
	-063-A22-AN11-07	*	●		63	22	40	11.2	7	A	0.49
	-080-A27-AN11-09	*	●		80	27	50	11.2	9	A	1.18
	-100-B32-AN11-12		●		100	32	50	11.2	12	B	1.46
	-100-B32-AN11-12C	*	○		100	32	50	11.2	12	B	1.46
	-125-B40-AN11-14		●		125	40	63	11.2	14	B	2.92
	-125-B40-AN11-14C	*	○		125	40	63	11.2	14	B	2.92
	-160-C40-AN11-16		●		160	40	63	11.2	16	C	4.30
EMP13	-050-A22-AN15-04	*	●		50	22	40	14.5	4	A	0.26
	-063-A22-AN15-05	*	●		63	22	40	14.5	5	A	0.53
	-080-A27-AN15-06	*	●		80	27	50	14.5	6	A	1.23
	-100-B32-AN15-08		○		100	32	50	14.5	8	B	1.52
	-100-B32-AN15-08C	*	○		100	32	50	14.5	8	B	1.52
	-125-B40-AN15-10		●		125	40	63	14.5	10	B	3.05
	-125-B40-AN15-10C	*	○		125	40	63	14.5	10	B	3.05
	-160-C40-AN15-12		●		160	40	63	14.5	12	C	4.46

* Internal coolant · Innenkühlung

● Ex stock / ab Lager ○ On demand / auf Anfrage

Spare Parts · Ersatzteile

Diameter Durchmesser Ø D	Screw Schraube	Drehmoment Torque	Wrench Schlüssel	
Ø50-Ø160	I60M3x9	2 Nm	WT09IS	
	I60M4x12	3 Nm	WT15IS	

We recommend to use torque wrenches · Wir empfehlen den Einsatz von Drehmomentschlüsseln

Kr:90°



Square Shoulder Milling Tools · Eckfräser

EMP13 N

Weldon shank
Weldon-Schaft



Straight shank
Zylinder-Schaft

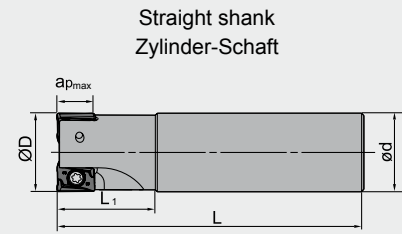
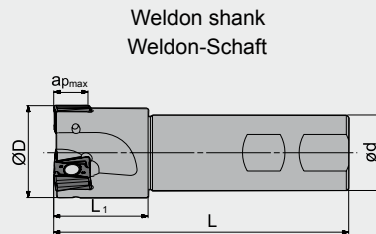

Specification of tools · Werkzeug Beschreibung

Type Typ	*	Stock Lager		Dimension (mm) Abmessung					No. of teeth Zähne	Weight Gewicht (kg)	
		R	L	ØD	Ød	L	L ₁	a _{pmax}			
Weldon shank Weldon-Schaft	EMP13 -025-XP25-AN11-02	*	●		25	25	100	32	11.2	2	0.31
	-032-XP32-AN11-03	*	●		32	32	115	40	11.2	3	0.61
	-040-XP32-AN11-04	*	●		40	32	125	40	11.2	4	0.75
	-032-XP32-AN15-02	*	●		32	32	125	40	11.2	2	0.66
	-040-XP32-AN15-03	*	●		40	32	125	40	11.2	3	0.76
Straight shank Zylinder-Schaft	EMP13 -025-G25-AN11-02	*	●		25	25	100	32	11.2	2	0.31
	-032-G32-AN11-03	*	●		32	32	115	40	11.2	3	0.61
	-040-G32-AN11-04	*	●		40	32	125	40	11.2	4	0.75
	-032-G32-AN15-02	*	●		32	32	125	40	14.5	2	0.66
	-040-G32-AN15-03	*	●		40	32	125	40	14.5	3	0.76

* Internal coolant · Innenkühlung

● Ex stock / ab Lager ○ On demand / auf Anfrage

Spare Parts · Ersatzteile

Diameter Durchmesser Ø D	Screw Schraube	Torque Drehmoment	Wrench Schlüssel	
Ø25-Ø40	I60M3x9	2 Nm	WT09IS	
Ø32-Ø40	I60M4x12	3 Nm	WT15IS	

We recommend to use torque wrenches · Wir empfehlen den Einsatz von Drehmomentschlüsseln

Square Shoulder Milling Tools · Eckfräser

Kr:90°



EMP13 N

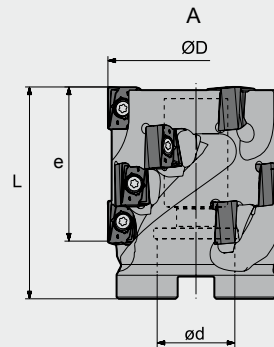

Specification of tools · Werkzeug Beschreibung

Type Typ	Stock Lager	Dimension (mm) Abmessung				No. of teeth Zähne	No. of inserts Plattenanzahl	Coupling Aufnahme	Weight Gewicht (kg)		
		R	L	ØD	Ød					L	e
EMP13	●			50	22	60	43	3	12	A	0.52
	○			63	27	80	64	4	24	A	1.15
	●			63	27	75	53	3	12	A	1.14
	●			80	32	75	53	4	16	A	1.82

● Ex stock / ab Lager ○ On demand / auf Anfrage

Spare Parts · Ersatzteile

Diameter Durchmesser Ø D	Screw Schraube	Torque Drehmoment	Wrench Schlüssel	
Ø25-Ø40	I60M3x9	2 Nm	WT09IS	
Ø32-Ø40	I60M4x12	3 Nm	WT15IS	

Square Shoulder Milling Tools · Eckfräser

Kr:90°



EMP13 N

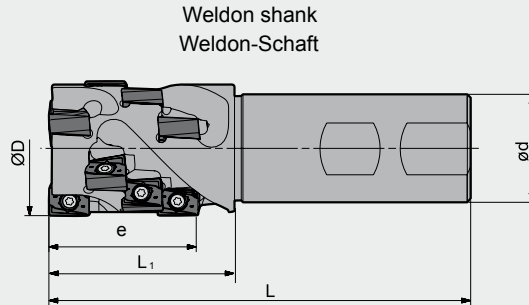
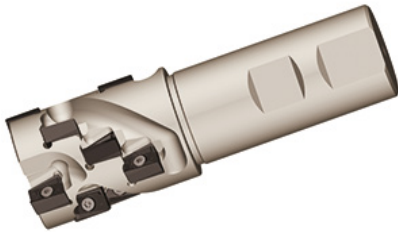

■ Specification of tools · Werkzeug Beschreibung

Type Typ	Stock Lager	Dimension (mm) Abmessung						No. of teeth Zähne	No. of inserts Plattenanzahl	Weight Gewicht (kg)	
		R	L	ØD	ød	L	L ₁				e
EMP13	●			32	32	115	48	43	2	8	0.61
	●			40	32	125	55	43	3	12	0.79
	●			40	32	115	55	40	2	6	0.79
	●			50	40	145	70	53	2	8	1.53

● Ex stock / ab Lager ○ On demand / auf Anfrage

■ Spare Parts · Ersatzteile

Diameter Durchmesser Ø D	Screw Schraube	Torque Drehmoment	Wrench Schlüssel	
Ø25-Ø40	I60M3x9	2 Nm	WT09IS	
Ø32-Ø40	I60M4x12	3 Nm	WT15IS	

We recommend to use torque wrenches · Wir empfehlen den Einsatz von Drehmomentschlüsseln

Milling · Fräsen

Indexable Milling Tools · Wendeplattenfräser

Applicable inserts · Wendschneidplatten

● Ideal Machining Condition / Gute Bearbeitungsbedingungen
 ● Normal Machining Condition / Normale Bearbeitungsbedingungen
 ● Unfavorable Machining Condition / Ungünstige Bearbeitungsbedingungen

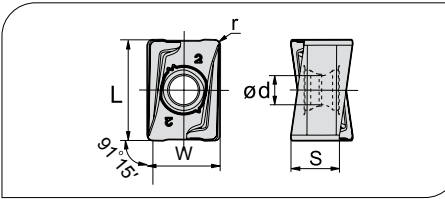

Workpiece Material / Werkstoffe	Material	Condition
P	Steel / Stahl	●
M	Stainless Steel / Rostfreier Stahl	●
K	Cast iron / Gusseisen	●
N	Non-ferrous material / Ne Metalle	●
S	Heat-resistant steel / Warmfester Stahl	●

Insert shape / Plattenform	Type / Typ	Dimension (mm) / Abmessung					CVD Coating / Beschichtung	PVD Coating / Beschichtung	Cermet / Cermet	Carbide uncoat. / unb. Hartm.
		L	W	S	Ø d	r				
	ANGX110504PNR-LH	11.85	8.4	5.7	3.5	0.8				YD101 ●
	ANGX150608PNR-LH	15.43	11.0	7.3	4.4	0.8				○

Recommended cutting data · Empfohlene Schnittdaten

Workpiece material / Werkstück Material	Hardness HB / Härte	Grade / Sorte	Cutting data · Schnittdaten	
			Square shoulder milling · Eckfräsen	
			V(m/min)	f(mm/z)
N Al alloy / Alu-Legierungen	----	YD101	300	-LH 0.2 (0.08-0.4)

Mounting double sided inserts:

Montage von doppelseitigen Wendschneidplatten bei Fräsern:

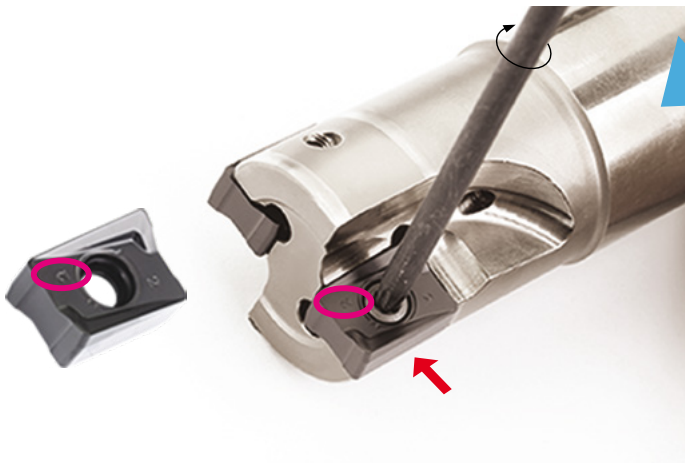

Please make sure that the faces with same marks are in the same direction.

Bitte stellen Sie sicher, dass die Platten mit derselben Markierung in dieselbe Richtung angebracht werden.

KMD401 (DLC)

New solid carbide grade for solid carbide cutters
Neue Hartmetallsorte für VHM-Fräser

For machining of non-ferrous metals
Für die Bearbeitung von Nichteisenmetallen

PVD coated carbide substrate for high performance milling application of non-ferrous metals, CFRP and GFRP and organic materials. The DLC layer has very good wear protection and high thermal stability.

PVD beschichtetes Hartmetallsubstrat geeignet für die Bearbeitung von Nichteisenmetallen, CFK und GFK und organische Materialien. Die DLC-Beschichtung hat einen hervorragenden Verschleißschutz und hohe thermische Stabilität.

Advantages of the coating
Vorteile der Beschichtung

- High coating hardness
- Protection against abrasive wear results in longer tool life
- Smooth coating surface with consistently sharp tool edges – even for micro tools
- Protection against adhesive wear and improved tool surface quality lead to reduced tooling costs
- Low coefficient of friction due to reduced roughness
- Low tendency to adhesion

- *Sehr hohe Schichthärte*
- *Schutz gegen abrasiven Verschleiß, dadurch längere Werkzeugstandzeiten*
- *Glatte Schichtoberfläche mit gleichbleibend scharfen Schneidkanten – auch bei Mikrowerkzeugen*
- *Schutz vor adhäsivem Verschleiß und verbesserte Werkzeugoberflächenqualität führen zu reduzierten Werkzeugkosten*
- *Niedriger Reibungskoeffizient durch geringe Rauheit*
- *Geringe Neigung zu Anhaftungen*

Milling · Fräsen

Solid Carbide end mills · Vollhartmetallschaftfräser

AL-2E

2-flute end mills with straight shank
2-Schneiden Schafffräser mit Zylinderschaft

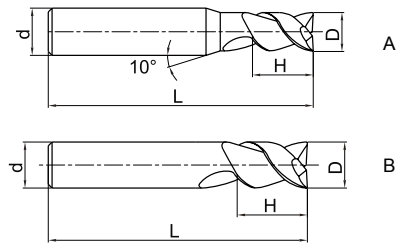
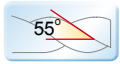

Type · Typ	Dimension (mm) Abmessungen				Teeth · Zähne Z	Geometry Ausführung	YK30F
	D	d	H	L			
AL-2E-D1.0	1.0	4	3	50	2	A	●
AL-2E-D1.5	1.5	4	4	50	2	A	●
AL-2E-D2.0	2.0	4	6	50	2	A	●
AL-2E-D2.5	2.5	4	7	50	2	A	●
AL-2E-D3.0	3.0	6	9	50	2	A	●
AL-2E-D4.0	4.0	6	12	50	2	A	●
AL-2E-D5.0	5.0	6	15	50	2	A	●
AL-2E-D6.0	6.0	6	18	60	2	B	●
AL-2E-D8.0	8.0	8	20	60	2	B	●
AL-2E-D10.0	10.0	10	30	75	2	B	●
AL-2E-D12.0	12.0	12	32	75	2	B	●
AL-2E-D16.0	16.0	16	45	100	2	B	●
AL-2E-D20.0	20.0	20	45	100	2	B	●

AL-2EL

2-flute long cutting edge end mills with straight shank
2-Schneiden Schafffräser mit langer Schneide und Zylinderschaft

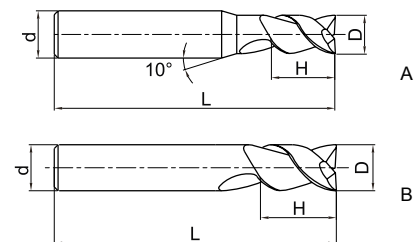
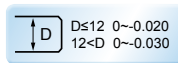

Type · Typ	Dimension (mm) Abmessungen				Teeth · Zähne Z	Geometry Ausführung	YK30F
	D	d	H	L			
AL-2EL-D3.0	3.0	6	12	60	2	A	●
AL-2EL-D4.0	4.0	6	16	60	2	A	●
AL-2EL-D5.0	5.0	6	20	60	2	A	●
AL-2EL-D6.0	6.0	6	25	75	2	B	●
AL-2EL-D8.0	8.0	8	32	75	2	B	●
AL-2EL-D10.0	10.0	10	45	100	2	B	●
AL-2EL-D12.0	12.0	12	45	100	2	B	●
AL-2EL-D16.0	16.0	16	65	150	2	B	●
AL-2EL-D20.0	20.0	20	75	150	2	B	●

AL-2E | AL-2EL

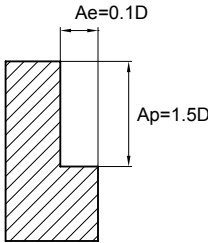
Workpiece material Werkstückstoff	Aluminum alloy Alu-Legierungen		Silicon aluminium alloy Si≤10% Silizium-Alu-Legierungen Si≤10%		
	Diameter Durchmesser Ø (mm)	Rotating Drehzahl (min ⁻¹)	Feed Vorschub (mm/min)	Rotating Drehzahl (min ⁻¹)	Feed Vorschub (mm/min)
1		40000	650	40000	500
2		40000	950	32000	750
3		26500	1500	21000	1100
4		20000	1600	16000	1250
5		16000	1500	13000	1100
6		13000	1250	10600	1000
8		10000	1400	8000	1100
10		8000	1600	6500	1250
12		6600	1650	5300	1300
14		5700	1700	4600	1350
16		5000	1700	4000	1350
18		4400	1700	3500	1350
20		4000	1700	3200	1350
Max. cutting depth max. Schnitttiefe	 <p>The diagram illustrates the maximum cutting parameters for a mill. It shows a cross-section of a workpiece being milled. The axial depth of cut is labeled as $A_e = 0.1D$, and the maximum cutting depth is labeled as $A_p = 1.5D$.</p>				

Milling · Fräsen

Solid Carbide end mills · Vollhartmetallschaftfräser

AL-3E

3-flute end mills with straight shank
3-Schneiden Schafffräser mit Zylinderschaft

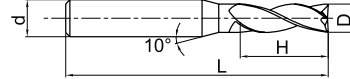
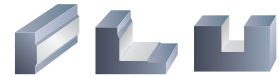

A

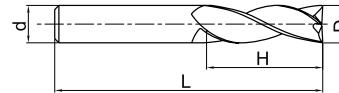

B

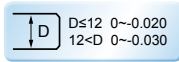
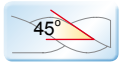

Type · Typ	Dimension (mm) Abmessungen				Teeth · Zähne Z	Geometry Ausführung	YK30F
	D	d	H	L			
AL-3E-D1.0	1.0	4	3	50	3	A	●
AL-3E-D1.5	1.5	4	4	50	3	A	●
AL-3E-D2.0	2.0	4	6	50	3	A	●
AL-3E-D2.5	2.5	4	7	50	3	A	●
AL-3E-D3.0	3.0	6	9	50	3	A	●
AL-3E-D4.0	4.0	6	12	50	3	A	●
AL-3E-D5.0	5.0	6	15	50	3	A	●
AL-3E-D6.0	6.0	6	18	60	3	B	●
AL-3E-D8.0	8.0	8	20	60	3	B	●
AL-3E-D10.0	10.0	10	30	75	3	B	●
AL-3E-D12.0	12.0	12	32	75	3	B	●
AL-3E-D16.0	16.0	16	45	100	3	B	●
AL-3E-D20.0	20.0	20	45	100	3	B	●

● Ex Stock / ab Lager ○ On demand / auf Anfrage

AL-3EL

3-flute end mills with straight shank and long cutting edge
3-Schneiden Schafffräser mit langer Schneide und Zylinderschaft

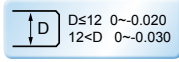
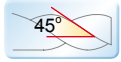
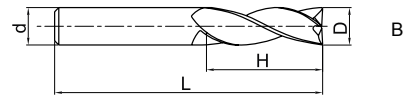
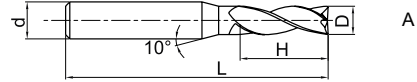

Type · Typ	Dimension (mm) Abmessungen				Teeth · Zähne Z	Geometry Ausführung	YK30F
	D	d	H	L			
AL-3EL-D3.0	3.0	6	12	60	3	A	●
AL-3EL-D4.0	4.0	6	16	60	3	A	●
AL-3EL-D5.0	5.0	6	20	60	3	A	●
AL-3EL-D6.0	6.0	6	25	75	3	B	●
AL-3EL-D8.0	8.0	8	32	75	3	B	●
AL-3EL-D10.0	10.0	10	45	100	3	B	●
AL-3EL-D12.0	12.0	12	45	100	3	B	●
AL-3EL-D16.0	16.0	16	65	150	3	B	●
AL-3EL-D20.0	20.0	20	75	150	3	B	●

● Ex Stock / ab Lager ○ On demand / auf Anfrage

Milling · Fräsen

Indexable Milling Tools · Wendeplattenfräser

AL-3E | AL-3EL

Workpiece material Werkstückstoff	Aluminum alloy Alu-Legierungen		Silicon aluminium alloy Si≤10% Silizium-Alu-Legierungen Si≤10%		
	Diameter Durchmesser Ø (mm)	Rotating Drehzahl (min ⁻¹)	Feed Vorschub (mm/min)	Rotating Drehzahl (min ⁻¹)	Feed Vorschub (mm/min)
1		40000	800	40000	600
2		40000	1200	32000	900
3		26500	1800	21000	1300
4		20000	2000	16000	1500
5		16000	1750	13000	1300
6		13000	1500	10600	1200
8		10000	1650	8000	1300
10		8000	1900	6500	1500
12		6600	1950	5300	1550
14		5700	2000	4600	1600
16		5000	2000	4000	1600
18		4400	2000	3500	1600
20		4000	2000	3200	1600
Max. cutting depth max. Schnitttiefe					

ALG-2E

- 2-flute router with flat end cut (uncoated)
- 2-Schneider mit flachem Stirnanschliff (ohne Beschichtung)

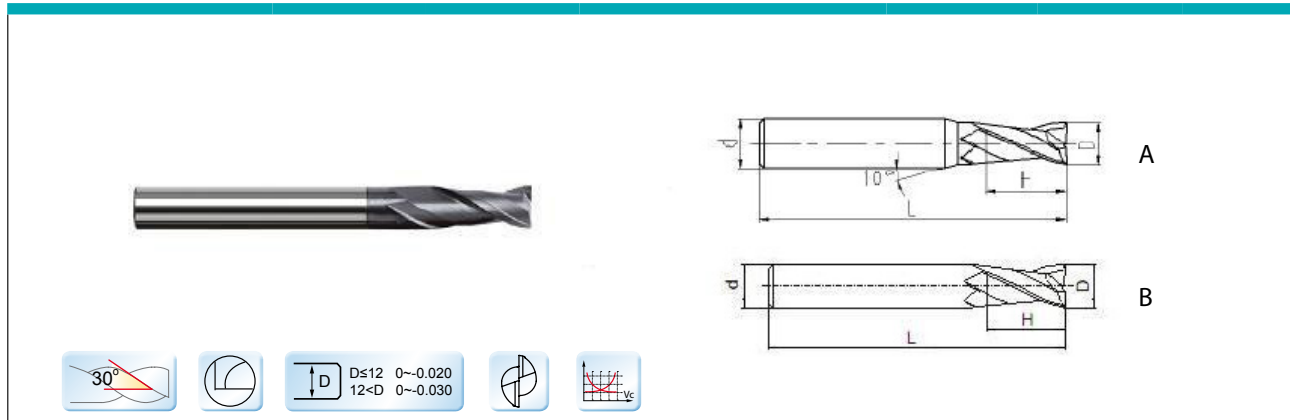

Type · Typ	Dimension (mm) Abmessungen				Teeth · Zähne Z	Geometry Ausführung	YK40F
	D	d	H	L			
ALG-2E-D1.0	1.0	4	3	50	2	A	●
ALG-2E-D1.5	1.5	4	4	50	2	A	●
ALG-2E-D2.0	2.0	4	6	50	2	A	●
ALG-2E-D2.5	2.5	4	8	50	2	A	●
ALG-2E-D3.0S	3.0	4	8	50	2	A	●
ALG-2E-D3.0	3.0	6	8	50	2	A	●
ALG-2E-D3.5S	3.5	4	10	50	2	A	○
ALG-2E-D3.5	3.5	6	10	50	2	A	●
ALG-2E-D4.0S	4.0	4	11	50	2	B	○
ALG-2E-D4.0	4.0	6	11	50	2	A	●
ALG-2E-D4.5	4.5	6	11	50	2	A	○
ALG-2E-D5.0	5.0	6	13	50	2	A	●
ALG-2E-D5.5	5.5	6	16	50	2	A	●
ALG-2E-D6.0	6.0	6	16	50	2	B	●
ALG-2E-D7.0	7.0	8	20	60	2	A	●
ALG-2E-D8.0	8.0	8	20	60	2	B	●
ALG-2E-D9.0	9.0	10	22	75	2	A	●
ALG-2E-D10.0	10.0	10	25	75	2	B	●
ALG-2E-D11.0	11.0	12	26	75	2	A	●
ALG-2E-D12.0	12.0	12	30	75	2	B	●
ALG-2E-D14.0	14.0	14	32	75	2	B	●
ALG-2E-D16.0	16.0	16	45	100	2	B	●
ALG-2E-D18.0	18.0	18	45	100	2	B	●
ALG-2E-D20.0	20.0	20	45	100	2	B	●

Further dimensions available on request
 Weitere Abmessungen auf Anfrage lieferbar

● Ex Stock / ab Lager ○ On demand / auf Anfrage

Milling · Fräsen

Indexable Milling Tools · Wendeplattenfräser

ALG-2E

Workpiece material Werkstückstoff	Aluminum alloy Alu-Legierungen		Silicon aluminium alloy Si≤10% Silizium-Alu-Legierungen Si≤10%		
	Diameter Durchmesser Ø (mm)	Rotating Drehzahl (min ⁻¹)	Feed Vorschub (mm/min)	Rotating Drehzahl (min ⁻¹)	Feed Vorschub (mm/min)
1		40000	800	40000	600
2		40000	1200	32000	900
3		26500	1800	21000	1300
4		20000	2000	16000	1500
5		16000	1750	13000	1300
6		13000	1500	10600	1200
8		10000	1650	8000	1300
10		8000	1900	6500	1500
12		6600	1950	5300	1550
Max. cutting depth max. Schnitttiefe	<p>The diagrams illustrate the maximum cutting depth (Ap) for different materials. The left diagram shows a cross-section of a workpiece with a diameter D and a cutting depth Ap = 1.5D. The right diagram shows a cross-section of a workpiece with a diameter D and a cutting depth Ap = 0.5D.</p>				

ALG-3E

- 3-flute router with flat end cut (uncoated)
- 3-Schneider mit flachem Stirnanschliff (ohne Beschichtung)

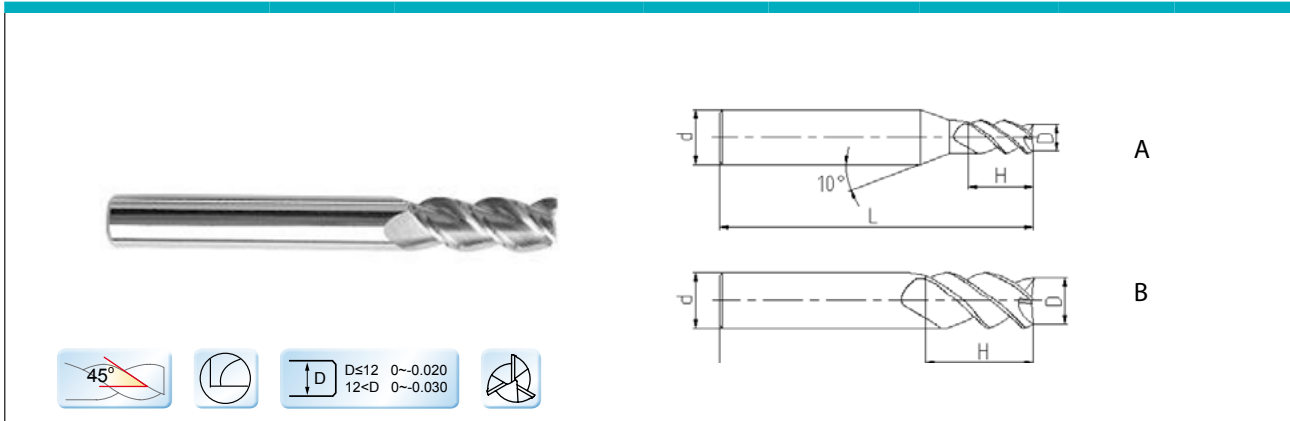

Type · Typ	Dimension (mm) Abmessungen				Teeth · Zähne Z	Geometry Ausführung	YK40F	KMD401
	D	d	H	L				
ALG-3E-D1.0	1.0	4	3	50	3	A	●	●
ALG-3E-D1.5	1.5	4	4	50	3	A	●	●
ALG-3E-D2.0	2.0	4	6	50	3	A	●	●
ALG-3E-D2.5	2.5	4	8	50	3	A	●	●
ALG-3E-D3.0S	3.0	4	8	50	3	A	●	●
ALG-3E-D3.0	3.0	6	8	50	3	A	●	●
ALG-3E-D4.0S	4.0	4	11	50	3	B	●	●
ALG-3E-D4.0	4.0	6	11	50	3	A	●	●
ALG-3E-D4.5	4.5	6	11	50	3	A	●	●
ALG-3E-D5.0	5.0	6	13	50	3	A	●	●
ALG-3E-D5.5	5.5	6	16	50	3	A	●	●
ALG-3E-D6.0	6.0	6	16	50	3	B	●	●
ALG-3E-D7.0	7.0	8	20	60	3	B	●	●
ALG-3E-D8.0	8.0	8	20	60	3	B	●	●
ALG-3E-D9.0	9.0	10	22	75	3	B	●	●
ALG-3E-D10.0	10.0	10	25	75	3	B	●	●
ALG-3E-D11.0	11.0	12	26	75	3	B	●	●
ALG-3E-D12.0	12.0	12	30	75	3	B	●	●
ALG-3E-D14.0	14.0	14	32	75	3	B	●	●
ALG-3E-D16.0	16.0	16	45	100	3	B	●	●
ALG-3E-D20.0	20.0	20	45	100	3	B	○	○

Further dimensions available on request
Weitere Abmessungen auf Anfrage lieferbar

- Ex Stock / ab Lager
- On demand / auf Anfrage

Milling · Fräsen

Solid Carbide end mills · Vollhartmetallschaftfräser

ALG-3E

Workpiece material Werkstückstoff	Aluminum alloy Alu-Legierungen		Silicon aluminium alloy Si≤10% Silizium-Alu-Legierungen Si≤10%		
	Diameter Durchmesser Ø (mm)	Rotating Drehzahl (min ⁻¹)	Feed Vorschub (mm/min)	Rotating Drehzahl (min ⁻¹)	Feed Vorschub (mm/min)
1		40000	800	40000	600
2		40000	1200	32000	900
3		26500	1800	21000	1300
4		20000	2000	16000	1500
5		16000	1750	13000	1300
6		13000	1500	10600	1200
8		10000	1650	8000	1300
10		8000	1900	6500	1500
12		6600	1950	5300	1550
Max. cutting depth max. Schnitttiefe					

ALG-3E-W

- 3-flute router with flat end cut (uncoated)
- 3-Schneider mit flachem Stirnanschliff (ohne Beschichtung)

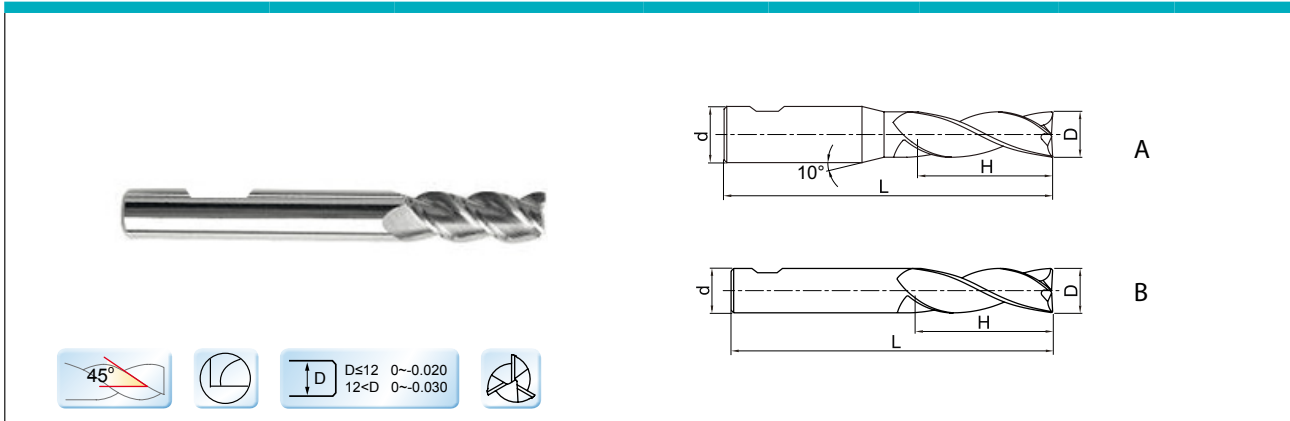

Type · Typ	Dimension (mm) Abmessungen				Teeth · Zähne Z	Geometry Ausführung	YK40F	KMD401
	D	d	H	L				
ALG-3E-D3.0-W	3.0	6	8	50	3	A	●	●
ALG-3E-D4.0-W	4.0	6	11	50	3	A	●	●
ALG-3E-D4.5-W	4.5	6	11	50	3	A	●	●
ALG-3E-D5.0-W	5.0	6	13	50	3	A	●	●
ALG-3E-D5.5-W	5.5	6	16	50	3	A	●	●
ALG-3E-D6.0-W	6.0	6	16	50	3	B	●	●
ALG-3E-D7.0-W	7.0	8	20	60	3	B	●	●
ALG-3E-D8.0-W	8.0	8	20	60	3	B	●	●
ALG-3E-D9.0-W	9.0	10	22	75	3	B	●	●
ALG-3E-D10.0-W	10.0	10	25	75	3	B	●	●
ALG-3E-D11.0-W	11.0	12	26	75	3	B	●	●
ALG-3E-D12.0-W	12.0	12	30	75	3	B	●	●
ALG-3E-D14.0-W	14.0	14	32	75	3	B	●	●
ALG-3E-D16.0-W	16.0	16	45	100	3	B	●	●
ALG-3E-D20.0-W	20.0	20	45	100	3	B	○	○

Further dimensions available on request
 Weitere Abmessungen auf Anfrage lieferbar

- Ex Stock / ab Lager
- On demand / auf Anfrage

Milling · Fräsen

Solid Carbide end mills · Vollhartmetallschaftfräser

ALG-3E-W

Workpiece material Werkstückstoff	Aluminum alloy Alu-Legierungen		Silicon aluminium alloy Si≤10% Silizium-Alu-Legierungen Si≤10%		
	Diameter Durchmesser Ø (mm)	Rotating Drehzahl (min ⁻¹)	Feed Vorschub (mm/min)	Rotating Drehzahl (min ⁻¹)	Feed Vorschub (mm/min)
1		40000	800	40000	600
2		40000	1200	32000	900
3		26500	1800	21000	1300
4		20000	2000	16000	1500
5		16000	1750	13000	1300
6		13000	1500	10600	1200
8		10000	1650	8000	1300
10		8000	1900	6500	1500
12		6600	1950	5300	1550
Max. cutting depth max. Schnitttiefe					

ALG-2R for air space industry · für Luft- und Raumfahrt - Industrie

2-flute radius end mills with long straight shank
2-Schneiden Radiusfräser mit langem Zylinderschaft

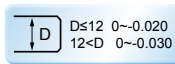
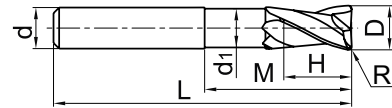

Type Typ	Dimension(mm) Abmessungen							Teeth Zähne Z	YK40F	KMD401
	D	R	d	d ₁	H	M	L			
ALG-2R-D6.0R0.3	6	0,3	6	5,7	8	29	75	2	●	●
ALG-2R-D6.0R0.5	6	0,5	6	5,7	8	29	75	2	●	●
ALG-2R-D6.0R1.0	6	1	6	5,7	8	29	75	2	●	●
ALG-2R-D8.0R0.3	8	0,3	8	7,4	10	29	75	2	●	●
ALG-2R-D8.0R0.5	8	0,5	8	7,4	10	29	75	2	●	●
ALG-2R-D8.0R1.0	8	1	8	7,4	10	29	75	2	●	●
ALG-2R-D10.0R0.5	10	0,5	10	9,4	12	50	100	2	●	●
ALG-2R-D10.0R1.0	10	1	10	9,4	12	50	100	2	●	●
ALG-2R-D10.0R1.6	10	1,6	10	9,4	12	50	100	2	●	●
ALG-2R-D10.0R2.5	10	2,5	10	9,4	12	50	100	2	●	●
ALG-2R-D12.0R0.5	12	0,5	12	11,4	15	45	100	2	●	●
ALG-2R-D12.0R1.0	12	1	12	11,4	15	45	100	2	●	●
ALG-2R-D12.0R1.6	12	1,6	12	11,4	15	45	100	2	●	●
ALG-2R-D12.0R2.5	12	2,5	12	11,4	15	45	100	2	●	●
ALG-2R-D12.0R3.2	12	3,2	12	11,4	15	45	100	2	●	●
ALG-2R-D12.0R4.0	12	4	12	11,4	15	45	100	2	●	●
ALG-2R-D16.0R1.0	16	1	16	15,4	15	67	125	2	●	●
ALG-2R-D16.0R1.6	16	1,6	16	15,4	15	67	125	2	●	●
ALG-2R-D16.0R2.5	16	2,5	16	15,4	15	67	125	2	●	●
ALG-2R-D16.0R3.2	16	3,2	16	15,4	15	67	125	2	●	●
ALG-2R-D16.0R4.0	16	4	16	15,4	15	67	125	2	●	●
ALG-2R-D16.0R6.3	16	6,3	16	15,4	15	67	125	2	●	●
ALG-2R-D20.0R1.0	20	1	20	18	20	65	125	2	●	●
ALG-2R-D20.0R1.6	20	1,6	20	18	20	65	125	2	●	●
ALG-2R-D20.0R2.5	20	2,5	20	18	20	65	125	2	●	●
ALG-2R-D20.0R3.2	20	3,2	20	18	20	65	125	2	●	●
ALG-2R-D20.0R4.0	20	4	20	18	20	65	125	2	●	●
ALG-2R-D20.0R6.3	20	6,3	20	18	20	65	125	2	○	○
ALG-2R-D25.0R6.3	25	6,3	25	23	25	75	150	2	○	○

● Ex Stock / ab Lager ○ On demand / auf Anfrage

Milling · Fräsen

Solid Carbide end mills · Vollhartmetallschaftfräser

ALG-2R

Workpiece material Werkstückstoff	Aluminum alloy Alu-Legierungen		Silicon aluminium alloy Si≤10% Silizium-Alu-Legierungen Si≤10%		
	Diameter Durchmesser Ø (mm)	Rotating Drehzahl (min ⁻¹)	Feed Vorschub (mm/min)	Rotating Drehzahl (min ⁻¹)	Feed Vorschub (mm/min)
1		40000	800	40000	600
2		40000	1200	32000	900
3		26500	1800	21000	1300
4		20000	2000	16000	1500
5		16000	1750	13000	1300
6		13000	1500	10600	1200
8		10000	1650	8000	1300
10		8000	1900	6500	1500
12		6600	1950	5300	1550
Max. cutting depth max. Schnitttiefe					

ALG-2R-W for air space industry · für Luft- und Raumfahrt - Industrie

2-flute radius end mills with long straight shank
2-Schneiden Radiusfräser mit langem Zylinderschaft

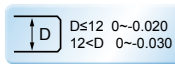
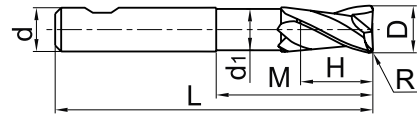

Type Typ	Dimension(mm) Abmessungen							Teeth Zähne Z	YK40F	KMD401
	D	R	d	d ₁	H	M	L			
ALG-2R-D6.0R0.3-W	6	0,3	6	5,7	8	29	75	2	●	●
ALG-2R-D6.0R0.5-W	6	0,5	6	5,7	8	29	75	2	●	●
ALG-2R-D6.0R1.0-W	6	1	6	5,7	8	29	75	2	●	●
ALG-2R-D8.0R0.3-W	8	0,3	8	7,4	10	29	75	2	●	●
ALG-2R-D8.0R0.5-W	8	0,5	8	7,4	10	29	75	2	●	●
ALG-2R-D8.0R1.0-W	8	1	8	7,4	10	29	75	2	●	●
ALG-2R-D10.0R0.5-W	10	0,5	10	9,4	12	50	100	2	●	●
ALG-2R-D10.0R1.0-W	10	1	10	9,4	12	50	100	2	●	●
ALG-2R-D10.0R1.6-W	10	1,6	10	9,4	12	50	100	2	●	●
ALG-2R-D10.0R2.5-W	10	2,5	10	9,4	12	50	100	2	●	●
ALG-2R-D12.0R0.5-W	12	0,5	12	11,4	15	45	100	2	●	●
ALG-2R-D12.0R1.0-W	12	1	12	11,4	15	45	100	2	●	●
ALG-2R-D12.0R1.6-W	12	1,6	12	11,4	15	45	100	2	●	●
ALG-2R-D12.0R2.5-W	12	2,5	12	11,4	15	45	100	2	●	●
ALG-2R-D12.0R3.2-W	12	3,2	12	11,4	15	45	100	2	●	●
ALG-2R-D12.0R4.0-W	12	4	12	11,4	15	45	100	2	●	●
ALG-2R-D16.0R1.0-W	16	1	16	15,4	15	67	125	2	●	●
ALG-2R-D16.0R1.6-W	16	1,6	16	15,4	15	67	125	2	●	●
ALG-2R-D16.0R2.5-W	16	2,5	16	15,4	15	67	125	2	●	●
ALG-2R-D16.0R3.2-W	16	3,2	16	15,4	15	67	125	2	●	●
ALG-2R-D16.0R4.0-W	16	4	16	15,4	15	67	125	2	●	●
ALG-2R-D16.0R6.3-W	16	6,3	16	15,4	15	67	125	2	●	●
ALG-2R-D20.0R1.0-W	20	1	20	18	20	65	125	2	●	●
ALG-2R-D20.0R1.6-W	20	1,6	20	18	20	65	125	2	●	●
ALG-2R-D20.0R2.5-W	20	2,5	20	18	20	65	125	2	●	●
ALG-2R-D20.0R3.2-W	20	3,2	20	18	20	65	125	2	●	●
ALG-2R-D20.0R4.0-W	20	4	20	18	20	65	125	2	●	●
ALG-2R-D20.0R6.3-W	20	6,3	20	18	20	65	125	2	○	○
ALG-2R-D25.0R6.3-W	25	6,3	25	23	25	75	150	2	○	○

● Ex Stock / ab Lager ○ On demand / auf Anfrage

Milling · Fräsen

Solid Carbide end mills · Vollhartmetallschaftfräser

ALG-2R-W

Workpiece material Werkstückstoff	Aluminum alloy Alu-Legierungen		Silicon aluminium alloy Si≤10% Silizium-Alu-Legierungen Si≤10%		
	Diameter Durchmesser Ø (mm)	Rotating Drehzahl (min ⁻¹)	Feed Vorschub (mm/min)	Rotating Drehzahl (min ⁻¹)	Feed Vorschub (mm/min)
1		40000	800	40000	600
2		40000	1200	32000	900
3		26500	1800	21000	1300
4		20000	2000	16000	1500
5		16000	1750	13000	1300
6		13000	1500	10600	1200
8		10000	1650	8000	1300
10		8000	1900	6500	1500
12		6600	1950	5300	1550
Max. cutting depth max. Schnitttiefe					

ALP-3E

- 3-flute router with flat end cut (uncoated) (MQL)
- 3-Schneider mit flachem Stirnanschliff (unbeschichtet) (MMKS)

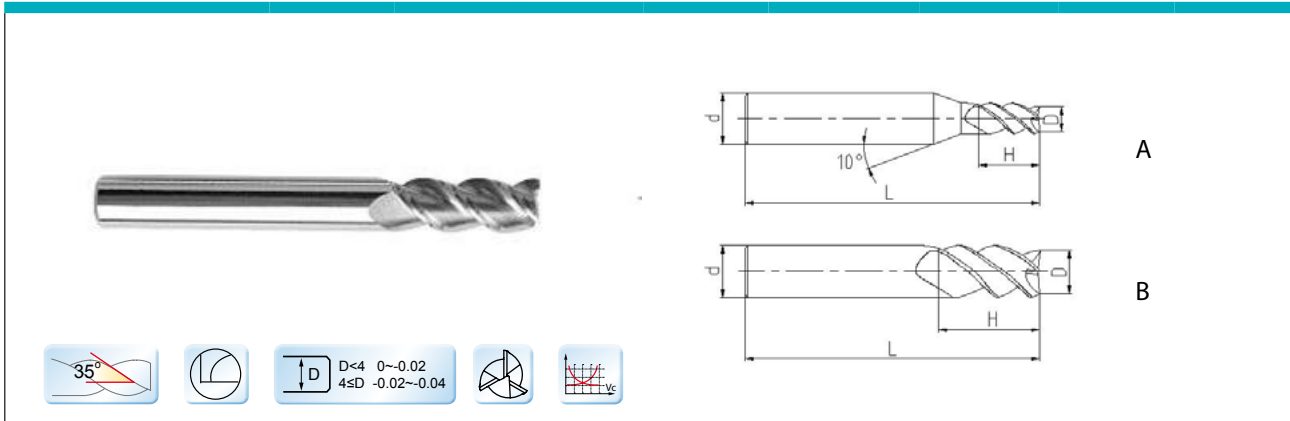

Type · Typ	Dimension (mm) Abmessungen				Teeth · Zähne Z	Geometry Ausführung	YK40F	KMD401
	D	d	H	L				
ALP-3E-D1.0	1.0	4	3	50	3	A	●	●
ALP-3E-D1.5	1.5	4	4	50	3	A	●	●
ALP-3E-D2.0	2.0	4	6	50	3	A	●	●
ALP-3E-D2.5	2.5	4	8	50	3	A	●	●
ALP-3E-D3.0S	3.0	4	8	50	3	A	●	●
ALP-3E-D3.0	3.0	6	8	50	3	A	●	●
ALP-3E-D4.0S	4.0	4	11	50	3	B	●	●
ALP-3E-D4.0	4.0	6	11	50	3	A	●	●
ALP-3E-D4.5	4.5	6	11	50	3	A	●	●
ALP-3E-D5.0	5.0	6	13	50	3	A	●	●
ALP-3E-D5.5	5.5	6	16	50	3	A	●	●
ALP-3E-D6.0	6.0	6	16	50	3	B	●	●
ALP-3E-D7.0	7.0	8	20	60	3	B	●	●
ALP-3E-D8.0	8.0	8	20	60	3	B	●	●
ALP-3E-D9.0	9.0	10	22	75	3	B	●	●
ALP-3E-D10.0	10.0	10	25	75	3	B	●	●
ALP-3E-D11.0	11.0	12	26	75	3	B	●	●
ALP-3E-D12.0	12.0	12	30	75	3	B	●	●
ALP-3E-D14.0	14.0	14	32	75	3	B	●	●
ALP-3E-D16.0	16.0	16	45	100	3	B	●	●
ALP-3E-D20.0	20.0	20	45	100	3	B	○	○

Further dimensions available on request
 Weitere Abmessungen auf Anfrage lieferbar

● Ex Stock / ab Lager ○ On demand / auf Anfrage

Milling · Fräsen

Solid Carbide end mills · Vollhartmetallschaftfräser

ALP-3E

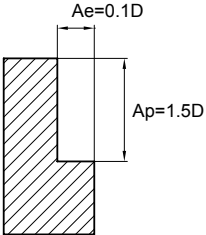
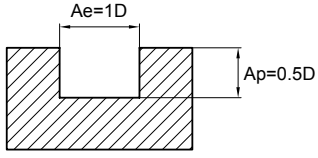
Workpiece material Werkstückstoff	Aluminum alloy Alu-Legierungen			
	Square sholder milling Schulterfräsen		Slot milling Nutenfräsen	
Diameter Durchmesser Ø (mm)	Rotating Drehzahl (min^{-1})	Feed Vorschub (mm/min)	Rotating Drehzahl (min^{-1})	Feed Vorschub (mm/min)
1	95000	1500	95000	900
2	65000	1200	65000	1000
3	53000	2200	53000	1600
4	40000	2500	40000	1800
5	31000	2700	31000	1900
6	26000	2800	26000	1900
8	20000	2700	20000	2000
10	16000	2600	16000	1900
12	13000	2500	13000	1800
16	10000	2300	10000	1700
Max. cutting depth max. Schnitttiefe				

ALP-3E-W

- 3-flute router with flat end cut (uncoated) (MQL)
- 3-Schneider mit flachem Stirnanschliff (unbeschichtet) (MMKS)

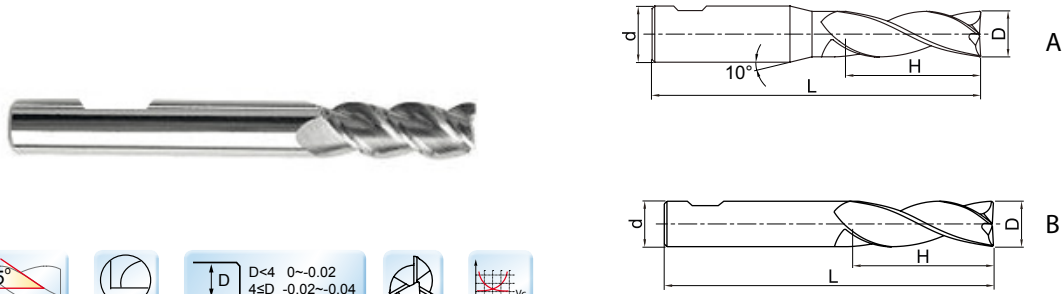

Technical drawings A and B show the dimensions of the router: D (outer diameter), d (inner diameter), H (flute length), and L (total length). Drawing A shows a 10-degree angle at the end of the flute. Drawing B shows a different flute geometry.

Type · Typ	Dimension (mm) Abmessungen				Teeth · Zähne Z	Geometry Ausführung	YK40F	KMD401
	D	d	H	L				
ALP-3E-D3.0-W	3.0	6	8	50	3	A	●	●
ALP-3E-D4.0-W	4.0	6	11	50	3	A	●	●
ALP-3E-D4.5-W	4.5	6	11	50	3	A	●	●
ALP-3E-D5.0-W	5.0	6	13	50	3	A	●	●
ALP-3E-D5.5-W	5.5	6	16	50	3	A	●	●
ALP-3E-D6.0-W	6.0	6	16	50	3	B	●	●
ALP-3E-D7.0-W	7.0	8	20	60	3	B	●	●
ALP-3E-D8.0-W	8.0	8	20	60	3	B	●	●
ALP-3E-D9.0-W	9.0	10	22	75	3	B	●	●
ALP-3E-D10.0-W	10.0	10	25	75	3	B	●	●
ALP-3E-D11.0-W	11.0	12	26	75	3	B	●	●
ALP-3E-D12.0-W	12.0	12	30	75	3	B	●	●
ALP-3E-D14.0-W	14.0	14	32	75	3	B	●	●
ALP-3E-D16.0-W	16.0	16	45	100	3	B	●	●
ALP-3E-D20.0-W	20.0	20	45	100	3	B	○	○

Further dimensions available on request
 Weitere Abmessungen auf Anfrage lieferbar

- Ex Stock / ab Lager
- On demand / auf Anfrage

Milling · Fräsen

Solid Carbide end mills · Vollhartmetallschaftfräser

ALP-3E-W

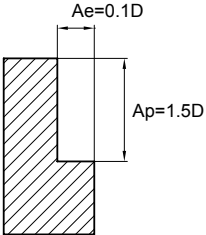
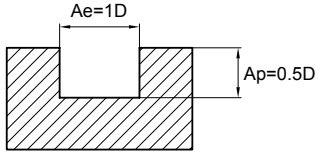
Workpiece material Werkstückstoff	Aluminum alloy Alu-Legierungen			
	Square sholder milling Schulterfräsen		Slot milling Nutenfräsen	
Diameter Durchmesser Ø (mm)	Rotating Drehzahl (min^{-1})	Feed Vorschub (mm/min)	Rotating Drehzahl (min^{-1})	Feed Vorschub (mm/min)
1	95000	1500	95000	900
2	65000	1200	65000	1000
3	53000	2200	53000	1600
4	40000	2500	40000	1800
5	31000	2700	31000	1900
6	26000	2800	26000	1900
8	20000	2700	20000	2000
10	16000	2600	16000	1900
12	13000	2500	13000	1800
16	10000	2300	10000	1700
Max. cutting depth max. Schnitttiefe				

ALP-4E

- 4-flute router with flat end cut (uncoated)
- 4-Schneider mit flachem Stirnanschliff (unbeschichtet)

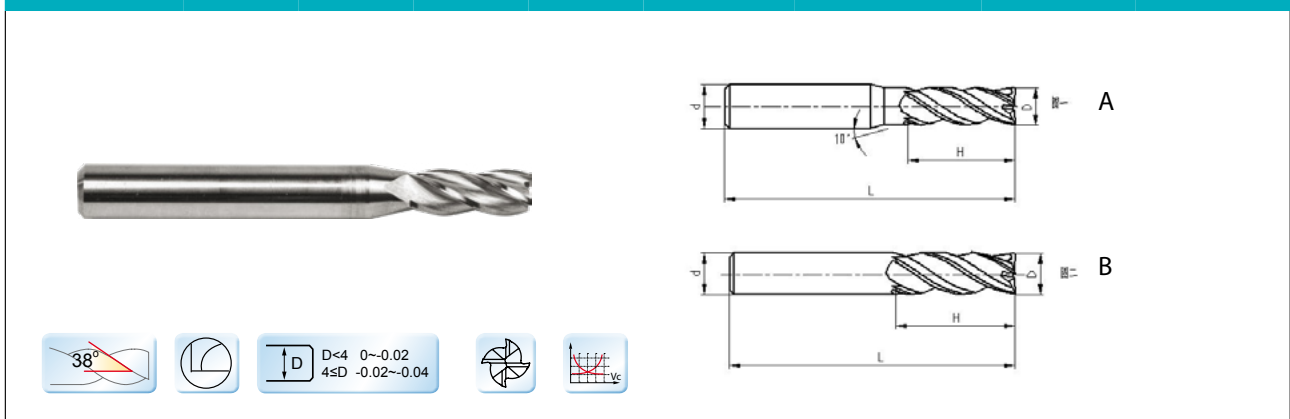

Type · Typ	Dimension (mm) Abmessungen				Teeth · Zähne Z	Geometry Ausführung	YK40F	KMD401
	D	d	H	L				
ALP-4E-D3.0S	3	4	9	50	4	A	●	●
ALP-4E-D3.0	3	6	9	50	4	A	●	●
ALP-4E-D4.0S	4	4	11	50	4	B	●	●
ALP-4E-D4.0	4	6	11	50	4	A	●	●
ALP-4E-D5.0	5	6	13	50	4	A	●	●
ALP-4E-D6.0	6	6	16	50	4	B	●	●
ALP-4E-D8.0	8	8	20	60	4	B	●	●
ALP-4E-D10.0	10	10	25	75	4	B	●	●
ALP-4E-D12.0	12	12	30	75	4	B	●	●
ALP-4E-D16.0	16	16	45	100	4	B	●	●
ALP-4E-D18.0	18	18	45	100	4	B	○	○
ALP-4E-D20.0	20	20	45	100	4	B	●	●

Further dimensions available on request
 Weitere Abmessungen auf Anfrage lieferbar

- Ex Stock / ab Lager
- On demand / auf Anfrage

Milling · Fräsen

Indexable Milling Tools · Wendeplattenfräser

ALP-4E

Workpiece material <i>Werkstückstoff</i>	Aluminum alloy <i>Alu-Legierungen</i>			
	Square sholder milling <i>Schulterfräsen</i>		Slot milling <i>Nutenfräsen</i>	
Diameter Durchmesser Ø (mm)	Rotating Drehzahl (min^{-1})	Feed Vorschub (mm/min)	Rotating Drehzahl (min^{-1})	Feed Vorschub (mm/min)
3	53000	2200	53000	1600
4	40000	2500	40000	1800
5	31000	2700	31000	1900
6	26000	2800	26000	1900
8	20000	2700	20000	2000
10	16000	2600	16000	1900
12	13000	2500	13000	1800
16	10000	2300	10000	1700
20	8000	2400	8000	1600

Max. cutting depth max. Schnitttiefe	<p>Ae=0.1D Ap=1.5D</p>	<p>Ae=1D Ap=0.5D</p>
---	----------------------------	--------------------------

ALP-4E-W

- 4-flute router with flat end cut (uncoated)
- 4-Schneider mit flachem Stirnanschliff (unbeschichtet)

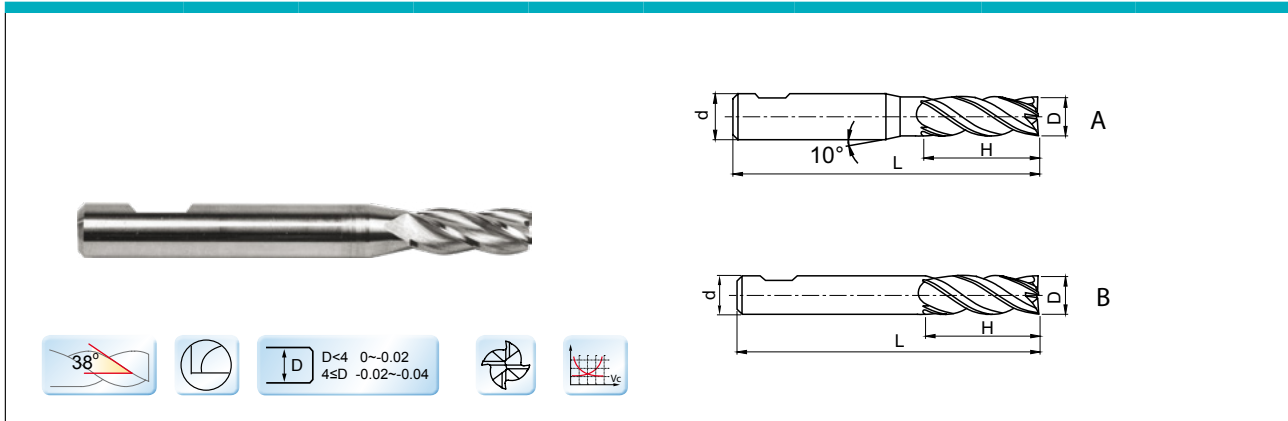

Type · Typ	Dimension (mm) Abmessungen				Teeth · Zähne Z	Geometry Ausführung	YK40F	KMD401
	D	d	H	L				
ALP-4E-D3.0-W	3	6	9	50	4	A	●	●
ALP-4E-D4.0-W	4	6	11	50	4	A	●	●
ALP-4E-D5.0-W	5	6	13	50	4	A	●	●
ALP-4E-D6.0-W	6	6	16	50	4	B	●	●
ALP-4E-D8.0-W	8	8	20	60	4	B	●	●
ALP-4E-D10.0-W	10	10	25	75	4	B	●	●
ALP-4E-D12.0-W	12	12	30	75	4	B	●	●
ALP-4E-D16.0-W	16	16	45	100	4	B	●	●
ALP-4E-D18.0-W	18	18	45	100	4	B	○	○
ALP-4E-D20.0-W	20	20	45	100	4	B	●	●

Further dimensions available on request
 Weitere Abmessungen auf Anfrage lieferbar

- Ex Stock / ab Lager
- On demand / auf Anfrage

Milling · Fräsen

Indexable Milling Tools · Wendeplattenfräser

ALP-4E-W

Workpiece material <i>Werkstückstoff</i>	Aluminum alloy <i>Alu-Legierungen</i>			
	Square sholder milling <i>Schulterfräsen</i>		Slot milling <i>Nutenfräsen</i>	
Diameter Durchmesser Ø (mm)	Rotating Drehzahl (min^{-1})	Feed Vorschub (mm/min)	Rotating Drehzahl (min^{-1})	Feed Vorschub (mm/min)
3	53000	2200	53000	1600
4	40000	2500	40000	1800
5	31000	2700	31000	1900
6	26000	2800	26000	1900
8	20000	2700	20000	2000
10	16000	2600	16000	1900
12	13000	2500	13000	1800
16	10000	2300	10000	1700
20	8000	2400	8000	1600

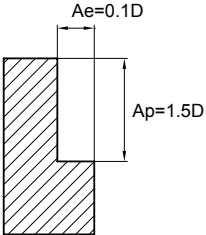
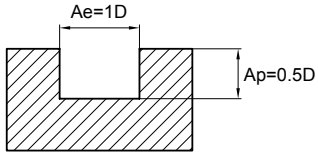
Max. cutting depth max. Schnitttiefe		
---	--	---

AL-3W

3-flute rough end mills with straight shank, rough pitch form
3-Schneiden Schruppfräser mit Zylinderschaft, grob verzahnt

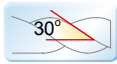
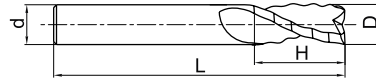

D	D≤6	0~-0.048	6<D≤10	0~-0.058
	10<D≤18	0~-0.07	18<D	0~-0.084



Type · Typ	Dimension (mm) Abmessungen				Teeth · Zähne Z	YK30F
	D	d	H	L		
AL-3W-D6.0	6	6	16	50	3	●
AL-3W-D8.0	8	8	20	60	3	●
AL-3W-D10.0	10	10	25	75	3	●
AL-3W-D12.0	12	12	30	75	3	●
AL-3W-D16.0	16	16	45	100	3	●
AL-3W-D20.0	20	20	45	100	3	●

● Ex Stock / ab Lager ○ On demand / auf Anfrage

Workpiece material Werkstückstoff	Aluminum alloy Alu-Legierungen		Silicon aluminium alloy Si≤10% Silizium-Alu-Legierungen Si≤10%	
Cutting speed Schnittgeschw.	250m/min		200m/min	
Diameter Durchmesser Ø (mm)	Rotating Drehzahl (min ⁻¹)	Feed Vorschub (mm/min)	Rotating Drehzahl (min ⁻¹)	Feed Vorschub (mm/min)
6	13000	3000	10600	1900
8	10000	3000	8000	1900
10	8000	2900	6500	1850
12	6600	2700	5300	1700
14	5700	2600	4600	1650
16	5000	2550	4000	1600
18	4400	2500	3500	1550
20	4000	2400	3200	1500

Max. cutting depth max. Schnitttiefe		
---	--	--

- The above table shows the reference value of side milling. When milling slot, rotating speed is around 70% of standard value. Feed is around 50% of standard value.
- Please select high rigid and precise machine and tool holder. Vibration and unusual noise may be generated if the machine rigidity and workpiece fixture stability is low, please reduce the rotating speed and feed stated above correspondingly.
- It is possible to increase the rotating speed and feed correspondingly if the cutting depth is small.
- Please use water-soluble cutting liquid.
- Down milling is recommended in side milling.
- Make overhang as short as possible if no interference.

- Die obige Tabelle zeigt die Referenz-Schnittdaten für das Eckfräsen. Für das Nutenfräsen die obigen Schnittdaten auf 70 % reduzieren.
- Bitte präzise Maschinen und Werkzeughalter verwenden. Bei Vibrationen oder unüblichen Geräuschen reduzieren Sie die Schnittdaten (wie oben empfohlen) entsprechend.
- Schnittdaten bei kleinen Schnitttiefen erhöhen.
- Bitte wasserlösliche Kühlmittel verwenden.
- Fräsmethode zum Eckfräsen: Gleichlaufräsen.
- Die Werkzeugauskragung so kurz wie möglich wählen.

Milling · Fräsen

Solid Carbide end mills · Vollhartmetallschaftfräser

AL-1E

- 1-flute router with flat end cut with 45° corner chamfer and polished flute (coated)
- 1-Schneider mit flachem Stirnanschliff mit 45° Eckenfase und polierter Nute (mit Beschichtung)

with new DLC-Coating
mit neuer DLC Beschichtung

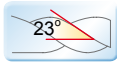
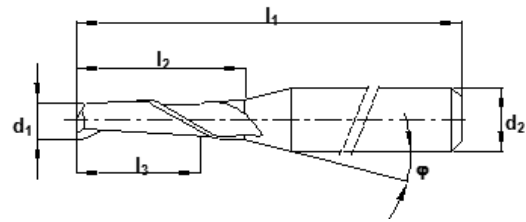

Article no. Artikel Nr.	Dimension (mm) Abmessung								
	d ₁	r	l ₃	l ₁	l ₂	d ₂	z	a	φ
598600	2,00	-	8,00	40,00	10,80	3,000	1	-	18
598599	2,00	-	4,50	50,00	7,30	6,000	1	-	18
598663	3,00	-	8,40	50,00	21,00	6,000	1	0,1	30
598662	3,00	-	12,40	50,00	14,00	6,000	1	-	14
598657	4,00	-	10,40	50,00	21,20	6,000	1	0,1	30
598661	4,00	-	12,40	50,00	16,00	6,000	1	-	11
598660	6,00	-	14,40	50,00	24,00	6,000	1	0,1	-
598656	6,00	-	15,00	50,00	-	6,000	1	-	-

Further dimensions available on request
Weitere Abmessungen auf Anfrage lieferbar

AL-1E

- 1-flute router with flat end cut with 45° corner chamfer and polished flute (uncoated)
- 1-Schneider mit flachem Stirnanschliff mit 45° Eckenfase und polierter Nute (ohne Beschichtung)

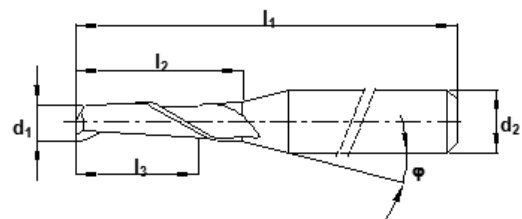

Article no. Artikel Nr.	Dimension (mm) Abmessung								
	d ₁	r	l ₃	l ₁	l ₂	d ₂	z	a	φ
598598	2,00	-	8,00	40,00	10,80	3,000	1	-	18
598597	2,00	-	4,50	50,00	7,30	6,000	1	-	18
598667	3,00	-	8,40	50,00	21,00	6,000	1	0,1	30
598666	3,00	-	12,40	50,00	14,00	6,000	1	-	14
598659	4,00	-	10,40	50,00	21,20	6,000	1	0,1	30
598665	4,00	-	12,40	50,00	16,00	6,000	1	-	11
598664	6,00	-	14,40	50,00	24,00	6,000	1	0,1	-
598658	6,00	-	15,00	50,00	-	6,000	1	-	-

Further dimensions available on request
Weitere Abmessungen auf Anfrage lieferbar

AI-1E Uncoated Unbeschichtet

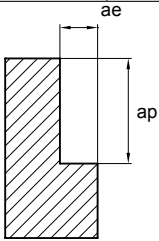
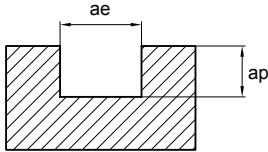
Aluminum alloy Alu-Legierungen						
Uncoated Unbeschichtet			Square sholder milling Schulterfräsen		Slot milling Nutenfräsen	
Diameter Durchmesser Ø (mm)	Rotating Drehzahl (min ⁻¹)	Feed Vorschub (mm/min)	ap [mm]	ae [mm]	ap [mm]	ae [mm]
2	33000	1000	3	0,4	2	2
3	22000	1000	4,5	0,6	3	3
4	16000	800	6	0,8	4	4
6	11000	600	9	1,2	6	1,2
Max. cutting depth max. Schnitttiefe						

AI-1E Coating Beschichtung

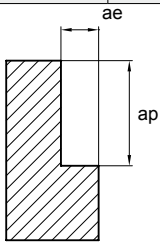
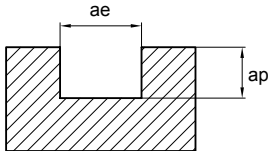
Aluminum alloy Alu-Legierungen						
Coating Beschichtung			Square sholder milling Schulterfräsen		Slot milling Nutenfräsen	
Diameter Durchmesser Ø (mm)	Rotating Drehzahl (min ⁻¹)	Feed Vorschub (mm/min)	ap [mm]	ae [mm]	ap [mm]	ae [mm]
2	40000	1000	3	0,40	2	2,00
3	27000	1000	4,5	0,60	3	3,00
4	20000	800	6	0,80	4	4,00
6	14000	600	9	1,20	6	6,00
Max. cutting depth max. Schnitttiefe						

Milling · Fräsen

Solid Carbide end mills · Vollhartmetallschaftfräser

DIN 6527L 2-flute end mills · **DIN 6527L** 2- Schneiden VHM Schaftfräser

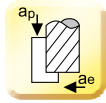

5502R402NM

YK30F: Ultrafine carbide / Ultrafeinkornhartmetall

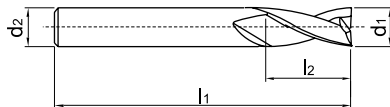

Type Typ	Dimension(mm) Abmessungen				Teeth Zähne	N
	d1(e8)	d2(h6)	l2	l1	z	YK30F
5502R402NM-0300	3.00	6	8	57	2	●
5502R402NM-0400	4.00	6	11	57	2	●
5502R402NM-0500	5.00	6	13	57	2	●
5502R402NM-0600	6.00	6	13	57	2	●
5502R402NM-0800	8.00	8	19	63	2	●
5502R402NM-1000	10.00	10	22	72	2	●
5502R402NM-1200	12.00	12	26	83	2	●
5502R402NM-1400	14.00	14	26	83	2	●
5502R402NM-1600	16.00	16	32	92	2	●
5502R402NM-1800	18.00	18	32	92	2	●
5502R402NM-2000	20.00	20	38	104	2	●

Art. Group No. / Produktgruppe Nr. :

022140

Milling - Fräsen

Solid Carbide end mills - Vollhartmetallschaftfräser

Type Typ	Grade Sorte	Material Werkstoffe	d1 (mm)	z	Vc (m/min)	fz (mm/z)	ap (mm)	ae (mm)	n (min ⁻¹)	Vf (mm/min)	
5502R402NM	YK30F	N	AL	3	2	350	0.02	2	0.3	37120	1485
				4	2	350	0.04	3	0.5	27840	2227
				5	2	350	0.06	6	1.0	22280	2673
				6	2	350	0.080	9	1.50	18560	2970
				8	2	350	0.100	12	2.00	13920	2784
				10	2	350	0.120	15	2.50	11140	2674
				12	2	350	0.140	18	3.00	9280	2598
				16	2	350	0.180	24	4.00	6960	2506
			20	2	350	0.220	30	5.00	5570	2451	
			Forged aluminium alloy geschmiedete AL-Legierung	3	2	350	0.02	2	0.3	95460	3819
				4	2	350	0.04	3	0.5	71580	5278
				5	2	350	0.06	6	1.0	57280	6873
				6	2	350	0.080	9	1.50	47740	7638
				8	2	350	0.100	12	2.00	35800	7160
				10	2	350	0.120	15	2.50	28640	6874
				12	2	350	0.140	18	3.00	23870	6684
				16	2	350	0.180	24	4.00	17900	6444
			Cast aluminium alloy AL-Gusslegierung Si<6%	3	2	350	0.02	2	0.3	95460	3819
				4	2	350	0.04	3	0.5	71580	5278
				5	2	350	0.06	6	1.0	57280	6873
				6	2	350	0.080	9	1.50	47740	7638
				8	2	350	0.100	12	2.00	35800	7160
				10	2	350	0.120	15	2.50	28640	6874
				12	2	350	0.140	18	3.00	23870	6684
				16	2	350	0.180	24	4.00	17900	6444
			Copper Kupfer	3	2	350	0.02	2	0.3	58340	2334
				4	2	350	0.04	3	0.5	43750	3500
				5	2	350	0.06	6	1.0	35000	4200
				6	2	350	0.080	9	1.50	29170	4667
				8	2	350	0.100	12	2.00	21880	4376
				10	2	350	0.120	15	2.50	17500	4200
				12	2	350	0.140	18	3.00	14580	4082
				16	2	350	0.180	24	4.00	10940	3938
			Plastic Kunststoff	3	2	350	0.02	2	0.3	127280	5091
				4	2	350	0.04	3	0.5	95460	7637
				5	2	350	0.06	6	1.0	76370	9164
				6	2	350	0.080	9	1.50	60000	9600
				8	2	350	0.100	12	2.00	47740	9548
				10	2	350	0.120	15	2.50	38190	9166
				12	2	350	0.140	18	3.00	31830	8912
				16	2	350	0.180	24	4.00	23870	8593
			20	2	350	0.220	30	5.00	19090	8400	



- Please start a test cutting with 85% of the Vc or 75% of the fz, then increase the cutting speed and feed rate.
- Please use high precision and high rigidity clamping system. The oscillation of the tool can not be over 0.01 mm.
 $N = 1000Vc / deff / 3.14159$
 When the rotating speed of the machine on site cannot reach the maximum rotation speed of the machine used for the calculation of the rotating speed: $Vf = fz * n * z$ (n: actual rotation of the machine).
- When $ap=1*d1$, $fz = 75\%$ as the data in the table.

- Bitte führen Sie einen Testschnitt mit 85% der Vc und 75% des fz durch.
 Nach erfolgtem Test können Sie die Schnittgeschwindigkeit bzw. die Vorschubwerte entsprechend erhöhen.
- Bitte verwenden Sie nur Spannmittel mit einer hohen Genauigkeit und einer hohen Spannkraft.
 Überprüfen Sie den Rundlauf der Werkzeuge. Sie sollten darauf achten, dass der Rundlauffehler nicht größer als 0.01 mm ist.

- Sollten Sie aufgrund der Machinendrehzahl nicht in der Lage sein, die angegebenen Drehzahlen ein zu halten, achten Sie darauf, dass Sie die Vf entsprechend anpassen. $Vf = fz * n * z$ (n: aktuelle Machinendrehzahl).
- Bei Fräsoperationen, die mit einer $ap=1*d1$ durchgeführt werden, ist fz um 25% zu reduzieren.

Milling · Fräsen

Solid Carbide end mills · Vollhartmetallschaftfräser

NM-2E

2-flute end mills with straight shank
2-Schneiden Schaftfräser mit Zylinderschaft

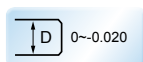
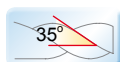
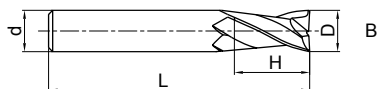
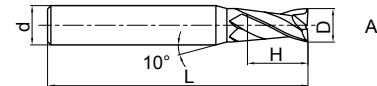

Type Typ	Dimension(mm) Abmessungen				Teeth Zähne Z	Geometry Ausführung	Grade Sorte KMG309
	D	d	H	L			
NM-2E-D1.0	1.0	4	3	50	2	A	●
NM-2E-D2.0	2.0	4	6	50	2	A	●
NM-2E-D3.0	3.0	6	8	50	2	A	●
NM-2E-D4.0	4.0	6	11	50	2	A	●
NM-2E-D5.0	5.0	6	13	50	2	A	●
NM-2E-D6.0	6.0	6	16	50	2	B	●
NM-2E-D8.0	8.0	8	20	60	2	B	●
NM-2E-D10.0	10.0	10	25	75	2	B	●
NM-2E-D12.0	12.0	12	30	75	2	B	●

NM-2E

Workpiece material Werkstück- material	Copper / Copper alloy Kupfer / Kupferlegierung	
Diameter Ø Durchmesser (mm)	Rotating Drehzahl (min ⁻¹)	Feed Vorschub (mm/min)
1	40000	1800
2	30000	2500
3	20000	2300
4	15000	2000
5	12000	1500
6	10000	1400
8	8000	1000
10	6500	900
12	5500	850

Max. cutting depth max Schnitttiefe	<p style="text-align: center;">Maximum Ae=1.0mm</p>	<p style="text-align: center;">Maximum Ap=1.0mm</p>
--	---	---

- The above table shows the reference value of side milling. The Feed in slot milling is recommended 70% of reference value stated above.
- Please select high rigid and precise machine and tool holder. Vibration and unusual noise may be generated if the machine rigidity and workpiece fixture stability is low, please reduce the rotating speed and feed stated above correspondingly.
- It is possible to increase the rotating speed and Feed correspondingly if the cutting depth is small.
- Please use water-soluble cutting liquid.
- Down milling is recommended in side milling.
- Make overhang as short as possible if no interference.

- Die obige Tabelle zeigt die Referenz Schnittdaten für das Eckfräsen.
Für das Nutenfräsen die obigen Schnittdaten um 30 % reduzieren.
- Bitte präzise Maschinen und Werkzeughalter verwenden. Bei Vibrationen oder unüblichen Geräuschen reduzieren Sie die Schnittdaten entsprechend.
- Schnittdaten bei kleinen Schnitttiefen erhöhen.
- Bitte wasserlösliche Kühlmittel verwenden.
- Fräsmethode zum Eckfräsen: Gleichlaufräsen.
- Die Werkzeugauskragung so kurz wie möglich wählen.

Milling · Fräsen

Solid Carbide end mills · Vollhartmetallschaftfräser

NM-4E

4-flute end mills with straight shank
4-Schneiden Schaftfräser mit Zylinderschaft

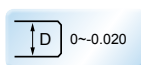
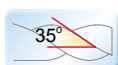
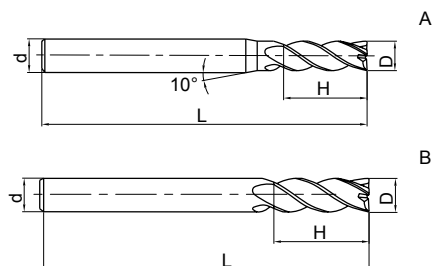

Type Typ	Dimension(mm) Abmessungen				Teeth Zähne Z	Geometry Ausführung	Grade Sorte KMG309
	D	d	H	L			
NM-4E-D3.0	3.0	6	8	50	4	A	○
NM-4E-D4.0	4.0	6	11	50	4	A	○
NM-4E-D5.0	5.0	6	13	50	4	A	○
NM-4E-D6.0	6.0	6	16	50	4	B	○
NM-4E-D8.0	8.0	8	20	60	4	B	○
NM-4E-D10.0	10.0	10	25	75	4	B	○
NM-4E-D12.0	12.0	12	30	75	4	B	○

NM-4E

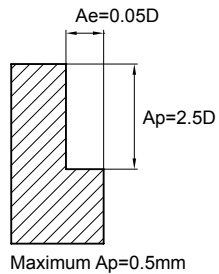
Workpiece material <i>Werkstück-material</i>	Copper / Copper alloy <i>Kupfer / Kupferlegierung</i>	
Diameter Ø <i>Durchmesser</i> (mm)	Rotating <i>Drehzahl</i> (min ⁻¹)	Feed <i>Vorschub</i> (mm/min)
3	10600	250
4	8000	300
5	6500	400
6	5300	400
8	4000	450
10	3500	450
12	3000	450
Max. cutting depth <i>max Schnitttiefe</i>	 <p>The diagram illustrates the maximum cutting depth parameters for the end mill. It shows a cross-section of the tool cutting into a workpiece. The axial cutting depth is labeled as $A_e = 0.05D$, where D is the diameter. The radial cutting depth is labeled as $A_p = 2.5D$. A note below the diagram states "Maximum $A_p = 0.5\text{mm}$".</p>	

1. Please select high rigid and precise machine and tool holder. Vibration and unusual noise may be generated if the machine rigidity and workpiece fixture stability is low, please reduce the rotating speed and feed stated above correspondingly.
2. It is possible to increase the rotating speed and feed correspondingly if the cutting depth is small.
3. Please use water-soluble cutting liquid.
4. Down milling is recommended in side milling.
5. Make overhang as short as possible if no interference.

1. Bitte Maschine und Werkzeugaufnahme mit hoher Präzision und Stabilität wählen. Bei Vibrationen oder unüblichen Geräuschen reduzieren Sie die Schnittdaten entsprechend.
2. Schnittdaten bei kleinen Schnitttiefen erhöhen.
3. Bitte wasserlösliche Kühlmittel verwenden.
4. Fräsmethode zum Eckfräsen: Gleichlaufräsen.
5. Die Werkzeugauskragung so kurz wie möglich wählen.

Milling · Fräsen

Solid Carbide end mills · Vollhartmetallschaftfräser

NM-2EP

2-flute short cutting edge end mills with straight shank with long neck
2-Schneiden Schaftfräser mit Zylinderschaft

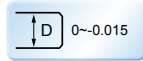
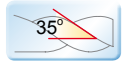
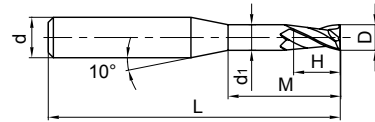

Type Typ	Dimension(mm) Abmessungen						Teeth Zähne Z	Grade Sorte KMG309
	D	d	H	M	d ₁	L		
NM-2EP-D0.5-M04	0.5	4.0	0.7	4.0	0.45	50	2	●
NM-2EP-D0.5-M06	0.5	4.0	0.7	6.0	0.45	50	2	●
NM-2EP-D0.5-M08	0.5	4.0	0.7	8.0	0.45	50	2	●
NM-2EP-D0.8-M04	0.8	4.0	1.2	4.0	0.75	50	2	●
NM-2EP-D0.8-M06	0.8	4.0	1.2	6.0	0.75	50	2	●
NM-2EP-D0.8-M08	0.8	4.0	1.2	8.0	0.75	50	2	●
NM-2EP-D0.8-M10	0.8	4.0	1.2	10.0	0.75	50	2	●
NM-2EP-D1.0-M04	1.0	4.0	1.5	4.0	0.95	50	2	●
NM-2EP-D1.0-M06	1.0	4.0	1.5	6.0	0.95	50	2	●
NM-2EP-D1.0-M08	1.0	4.0	1.5	8.0	0.95	50	2	●
NM-2EP-D1.0-M10	1.0	4.0	1.5	10.0	0.95	50	2	●
NM-2EP-D1.0-M12	1.0	4.0	1.5	12.0	0.95	50	2	●
NM-2EP-D1.0-M14	1.0	4.0	1.5	14.0	0.95	50	2	●
NM-2EP-D1.5-M08	1.5	4.0	2.3	8.0	1.45	50	2	●
NM-2EP-D1.5-M16	1.5	4.0	2.3	16.0	1.45	50	2	●
NM-2EP-D2.0-M06	2.0	4.0	3.0	6.0	1.95	50	2	●
NM-2EP-D2.0-M08	2.0	4.0	3.0	8.0	1.95	50	2	●
NM-2EP-D2.0-M10	2.0	4.0	3.0	10.0	1.95	50	2	●
NM-2EP-D2.0-M12	2.0	4.0	3.0	12.0	1.95	50	2	●
NM-2EP-D2.0-M14	2.0	4.0	3.0	14.0	1.95	50	2	●
NM-2EP-D2.0-M16	2.0	4.0	3.0	16.0	1.95	50	2	●
NM-2EP-D2.5-M10	2.5	4.0	3.7	10.0	2.4	50	2	●
NM-2EP-D2.5-M20	2.5	4.0	3.7	20.0	2.4	60	2	●
NM-2EP-D3.0-M10	3.0	6.0	4.5	10.0	2.85	50	2	●
NM-2EP-D3.0-M20	3.0	6.0	4.5	20.0	2.85	60	2	●
NM-2EP-D4.0-M16	4.0	6.0	6.0	16.0	3.85	60	2	●
NM-2EP-D4.0-M25	4.0	6.0	6.0	25.0	3.85	60	2	●
NM-2EP-D5.0-M16	5.0	6.0	7.5	16.0	4.85	60	2	●
NM-2EP-D5.0-M25	5.0	6.0	7.5	25.0	4.85	70	2	●

NM-2EP

Workpiece material Werkstückstoff		Copper / Copper alloy Kupfer / Kupferlegierung		
Diameter Ø Durchmesser (mm)	Effective length Effektive Länge (mm)	Rotating Drehzahl (min ⁻¹)	Feed Vorschub (mm/min)	a _p (mm)
0.5	4	40000	800	0.004
	6	40000	700	0.002
	8	40000	500	0.001
0.8	4	40000	1000	0.02
	6	40000	1000	0.015
	8	40000	800	0.01
	10	40000	600	0.005
1.0	4	40000	1800	0.04
	6	40000	1500	0.04
	8	40000	1500	0.03
	10	30000	1000	0.02
	12	30000	800	0.015
	14	30000	600	0.01
1.5	8	40000	2000	0.09
	16	20000	1000	0.03
2.0	6	40000	2400	0.18
	8	40000	2200	0.15
	10	40000	2000	0.12
	12	30000	1500	0.10
	14	30000	1200	0.08
	16	30000	1000	0.06
2.5	10	40000	2500	0.15
	20	20000	1000	0.08
3.0	10	20000	2500	0.20
	20	20000	2000	0.12
4.0	16	15000	1800	0.25
	25	15000	1200	0.15
5.0	16	12000	2000	0.40
	25	12000	1500	0.35

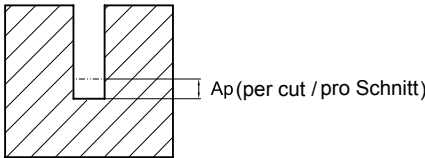
Max. cutting depth max Schnitttiefe	
--	--

1. Please select high precise machine and tool holder.
2. Please use water-soluble cutting liquid.
3. Make overhang as short as possible if no interference.

1. Bitte Maschine und Werkzeugaufnahme mit hoher Präzision und Stabilität wählen.
2. Bitte wasserlösliche Kühlmittel verwenden.
3. Die Werkzeugauskrantung so kurz wie möglich wählen.

Milling · Fräsen

Solid Carbide end mills · Vollhartmetallschaftfräser

NM-2BP

- 2-flute short cutting edge ball nose micro end mills with straight shank (long)
- 2-Schneiden Micro Kugelkopffräser, mit kurzer Schneide und Zylinderschaft (lang)

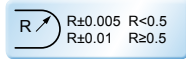
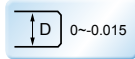
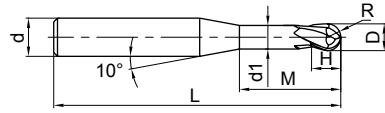

Type Typ	Dimension(mm) Abmessungen							Teeth Zähne Z	Grade Sorte KMG309
	D	R	H	d ₁	M	d	L		
NM-2BP-R0.25-M04	0.5	0.25	0.7	0.45	4.0	4.0	50	2	●
NM-2BP-R0.25-M06	0.5	0.25	0.7	0.45	6.0	4.0	50	2	●
NM-2BP-R0.3-M04	0.6	0.3	0.9	0.55	4.0	4.0	50	2	●
NM-2BP-R0.3-M06	0.6	0.3	0.9	0.55	6.0	4.0	50	2	●
NM-2BP-R0.3-M08	0.6	0.3	0.9	0.55	8.0	4.0	50	2	●
NM-2BP-R0.4-M04	0.8	0.4	1.2	0.75	4.0	4.0	50	2	●
NM-2BP-R0.4-M06	0.8	0.4	1.2	0.75	6.0	4.0	50	2	●
NM-2BP-R0.4-M08	0.8	0.4	1.2	0.75	8.0	4.0	50	2	●
NM-2BP-R0.4-M10	0.8	0.4	1.2	0.75	10.0	4.0	50	2	●
NM-2BP-R0.5-M04	1.0	0.5	1.5	0.95	4.0	4.0	50	2	●
NM-2BP-R0.5-M06	1.0	0.5	1.5	0.95	6.0	4.0	50	2	●
NM-2BP-R0.5-M08	1.0	0.5	1.5	0.95	8.0	4.0	50	2	●
NM-2BP-R0.5-M10	1.0	0.5	1.5	0.95	10.0	4.0	50	2	●
NM-2BP-R0.5-M12	1.0	0.5	1.5	0.95	12.0	4.0	50	2	●
NM-2BP-R0.75-M08	1.5	0.75	2.3	1.45	8.0	4.0	50	2	●
NM-2BP-R0.75-M16	1.5	0.75	2.3	1.45	16.0	4.0	50	2	●
NM-2BP-R1.0-M06	2.0	1.0	3.0	1.95	6.0	4.0	50	2	●
NM-2BP-R1.0-M08	2.0	1.0	3.0	1.95	8.0	4.0	50	2	●
NM-2BP-R1.0-M10	2.0	1.0	3.0	1.95	10.0	4.0	50	2	●
NM-2BP-R1.0-M12	2.0	1.0	3.0	1.95	12.0	4.0	50	2	●
NM-2BP-R1.0-M16	2.0	1.0	3.0	1.95	16.0	4.0	50	2	●
NM-2BP-R1.0-M20	2.0	1.0	3.0	1.95	20.0	4.0	60	2	●
NM-2BP-R1.5-M10	3.0	1.5	4.5	2.85	10.0	6.0	50	2	●
NM-2BP-R1.5-M20	3.0	1.5	4.5	2.85	20.0	6.0	60	2	●
NM-2BP-R2.0-M10	4.0	2.0	6.0	3.85	10.0	6.0	60	2	●
NM-2BP-R2.0-M16	4.0	2.0	6.0	3.85	16.0	6.0	60	2	●
NM-2BP-R2.0-M20	4.0	2.0	6.0	3.85	20.0	6.0	60	2	●
NM-2BP-R2.0-M25	4.0	2.0	6.0	3.85	25.0	6.0	60	2	●
NM-2BP-R2.5-M16	5.0	2.5	7.5	4.85	16.0	6.0	60	2	●
NM-2BP-R2.5-M25	5.0	2.5	7.5	4.85	25.0	6.0	70	2	●

NM-2BP

Workpiece material Werkstückstoff		Copper / Copper alloy Kupfer / Kupferlegierung			
Diameter Ø Durchmesser (mm)	Effective length Effektive Länge (mm)	Rotating Drehzahl (min ⁻¹)	Feed Vorschub (mm/min)	ap (mm)	ae (mm)
R0.25	4	40000	750	0.01	0.025
	6	36000	500	0.008	0.02
R0.3	4	40000	900	0.012	0.03
	6	40000	750	0.010	0.02
	8	30000	400	0.008	0.01
R0.4	4	40000	1050	0.016	0.04
	6	40000	800	0.012	0.03
	8	40000	500	0.01	0.02
	10	30000	400	0.008	0.01
R0.5	4	40000	1050	0.02	0.05
	6	40000	800	0.016	0.04
	8	40000	500	0.014	0.03
	10	33000	400	0.012	0.02
	12	35000	300	0.010	0.010
R0.75	8	40000	900	0.03	0.075
	16	20000	400	0.015	0.04
R1.0	6	40000	1100	0.04	0.10
	8	40000	900	0.034	0.08
	10	40000	750	0.028	0.065
	12	40000	500	0.022	0.05
	16	30000	400	0.018	0.04
	20	20000	300	0.012	0.03
R1.5	10	40000	1100	0.06	0.15
	20	32000	600	0.03	0.08
R2.0	10	32000	1100	0.08	0.20
	16	32000	900	0.06	0.16
	20	32000	600	0.04	0.12
	25	20000	400	0.02	0.08
R2.5	16	25000	1250	0.10	0.25
	25	20000	900	0.06	0.12

Max. cutting depth
max Schnitttiefe

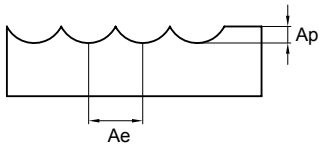

1. Please select high precise machine and tool holder.
2. Please use water-soluble cutting liquid.
3. Make overhang as short as possible if no interference.

1. Bitte Maschine und Werkzeugaufnahme mit hoher Präzision und Stabilität wählen.
2. Bitte wasserlösliche Kühlmittel verwenden.
3. Die Werkzeugauskragung so kurz wie möglich wählen.

Milling - Fräsen

Solid Carbide end mills - Vollhartmetallschaftfräser

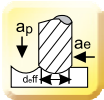

5565R302NH

YK40F: Ultrafine carbide / Ultrafeinkornhartmetall

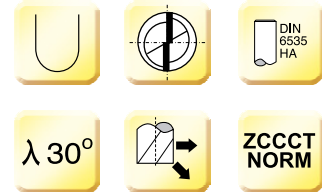
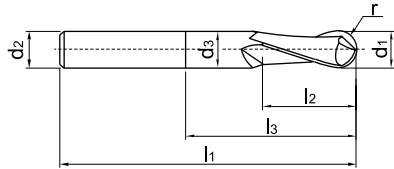

Type Typ	Dimension(mm) Abmessungen								Teeth Zähne	N
	d1	d2(h6)	l2	l1	d3	l3	r(f8)	α°		
5565R302NH-0300	3.00	6	6	57	2.80	9	1.50	6	2	●
5565R302NH-0400	4.00	6	8	57	3.70	12	2.00	4	2	●
5565R302NH-0500	5.00	6	10	57	4.60	15	2.50	2	2	●
5565R302NH-0600	6.00	6	12	57	5.50	20	3.00	-	2	●
5565R302NH-0800	8.00	8	16	63	7.40	26	4.00	-	2	●
5565R302NH-1000	10.00	10	20	72	9.20	31	5.00	-	2	●
5565R302NH-1200	12.00	12	24	83	11.00	37	6.00	-	2	●
5565R302NH-1600	16.00	16	32	92	15.00	43	8.00	-	2	●

Art. Group No. / Produktgruppe Nr. : 023140

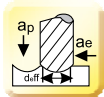

5566R302NH

YK40F: Ultrafine carbide / Ultrafeinkornhartmetall

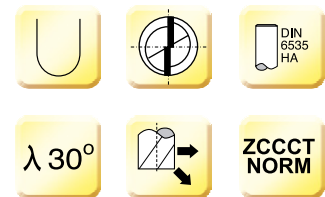
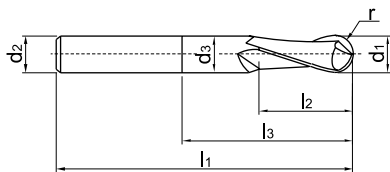

Type Typ	Dimension(mm) Abmessungen								Teeth Zähne	N
	d1	d2(h6)	l2	l1	d3	l3	r(f8)	α°		
5566R302NH-0300	3.00	6	6	75	2.80	9	1.50	6	2	●
5566R302NH-0400	4.00	6	8	75	3.70	12	2.00	4	2	●
5566R302NH-0500	5.00	6	10	80	4.60	15	2.50	2	2	●
5566R302NH-0600	6.00	6	12	80	5.50	20	3.00	-	2	●
5566R302NH-0800	8.00	8	16	90	7.40	26	4.00	-	2	●
5566R302NH-1000	10.00	10	20	100	9.20	31	5.00	-	2	●
5566R302NH-1200	12.00	12	24	120	11.00	37	6.00	-	2	●
5566R302NH-1600	16.00	16	32	140	15.00	43	8.00	-	2	●

Art. Group No. / Produktgruppe Nr. : 023140

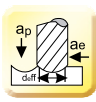
Type Typ	Grade Sorte	Material Werkstoffe	d1 (mm)	z	Vc (m/min)	fz (mm/z)	ap (mm)	ae (mm)	d _{eff} (mm)	
5565R302NH  	YK40F	N	Forged aluminum alloy <i>Geschmiedete Al-Legierung</i> Cast aluminum alloy <i>Al-Gusslegierung</i> Si<6%	3.00	2	900	0.060	0.30	0.60	1.80
				4.00	2	900	0.080	0.40	0.80	2.40
				5.00	2	900	0.100	0.50	1.00	3.00
				6.00	2	900	0.120	0.60	1.20	3.60
				8.00	2	900	0.150	0.80	1.60	4.80
				10.00	2	900	0.140	1.00	2.00	6.00
				12.00	2	900	0.170	1.20	2.40	7.20
			16.00	2	900	0.210	1.60	3.20	9.60	
			Copper <i>Kupfer</i>	3.00	2	600	0.060	0.30	0.60	1.80
				4.00	2	600	0.080	0.40	0.80	2.40
				5.00	2	600	0.100	0.50	1.00	3.00
				6.00	2	600	0.120	0.60	1.20	3.60
				8.00	2	600	0.150	0.80	1.60	4.80
				10.00	2	600	0.140	1.00	2.00	6.00
				12.00	2	600	0.170	1.20	2.40	7.20
			16.00	2	600	0.210	1.60	3.20	9.60	
			Plastic <i>Kunststoff</i>	3.00	2	1200	0.060	0.30	0.60	1.80
				4.00	2	1200	0.080	0.40	0.80	2.40
		5.00		2	1200	0.100	0.50	1.00	3.00	
		6.00		2	1200	0.120	0.60	1.20	3.60	
		8.00		2	1200	0.150	0.80	1.60	4.80	
		10.00		2	1200	0.140	1.00	2.00	6.00	
		12.00		2	1200	0.170	1.20	2.40	7.20	
		16.00	2	1200	0.210	1.60	3.20	9.60		

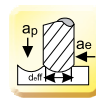
Type Typ	Grade Sorte	Material Werkstoffe	d1 (mm)	z	Vc (m/min)	fz (mm/z)	ap (mm)	ae (mm)	d _{eff} (mm)	
5566R302NH  	YK40F	N	Forged aluminum alloy <i>Geschmiedete Al-Legierung</i> Cast aluminum alloy <i>Al-Gusslegierung</i> Si<6%	3.00	2	650	0.060	0.15	0.30	1.31
				4.00	2	650	0.080	0.20	0.40	1.74
				5.00	2	650	0.100	0.25	0.50	2.18
				6.00	2	650	0.090	0.30	0.60	2.62
				8.00	2	650	0.120	0.40	0.80	3.49
				10.00	2	650	0.150	0.50	1.00	4.36
				12.00	2	650	0.120	0.60	1.20	5.23
			16.00	2	650	0.160	0.80	1.60	6.97	
			Copper <i>Kupfer</i>	3.00	2	480	0.060	0.15	0.30	1.31
				4.00	2	480	0.080	0.20	0.40	1.74
				5.00	2	480	0.100	0.25	0.50	2.18
				6.00	2	480	0.090	0.30	0.60	2.62
				8.00	2	480	0.120	0.40	0.80	3.49
				10.00	2	480	0.150	0.50	1.00	4.36
				12.00	2	480	0.120	0.60	1.20	5.23
			16.00	2	480	0.160	0.80	1.60	6.97	
			Plastic <i>Kunststoff</i>	3.00	2	950	0.060	0.15	0.30	1.31
				4.00	2	950	0.080	0.20	0.40	1.74
		5.00		2	950	0.100	0.25	0.50	2.18	
		6.00		2	950	0.090	0.30	0.60	2.62	
		8.00		2	950	0.120	0.40	0.80	3.49	
		10.00		2	950	0.150	0.50	1.00	4.36	
		12.00		2	950	0.120	0.60	1.20	5.23	
		16.00	2	950	0.160	0.80	1.60	6.97		

- Please start a test cutting with 85% of the Vc or 75% of the fz, then increase the cutting speed and feed rate.
 - Please use high precision and high rigidity clamping system. The oscillation of the tool can not be over 0.01 mm.
- $N = 1000Vc / d_{eff} / 3.14159$
- When the rotating speed of the machine on site cannot reach the maximum rotation speed of the machine used for the calculation of the rotating speed: $Vf = fz * n * z$ (n: actual rotation of the machine).

- Bitte führen Sie einen Testschnitt mit 85% der Vc und 75% des fz durch.
 - Nach erfolgtem Test können Sie die Schnittgeschwindigkeit bzw. die Vorschubwerte entsprechend erhöhen.
 - Bitte verwenden Sie nur Spannmittel mit einer hohen Genauigkeit und einer hohen Spannkraft.
- Überprüfen Sie den Rundlauf der Werkzeuge. Sie sollten darauf achten, dass der Rundlauffehler nicht größer als 0.01 mm ist.

Sollten Sie aufgrund der Machinendrehzahl nicht in der Lage sein, die angegebenen Drehzahlen ein zuhalten, achten Sie darauf, dass Sie die Vf entsprechend anpassen. $Vf = fz * n * z$ (n: aktuelle Machinendrehzahl).

Milling · Fräsen

Solid Carbide end mills · Vollhartmetallschaftfräser

AL-2B

2-flute ball nose end mills with straight shank
2-Schneiden Kugelkopffräser mit Zylinderschaft

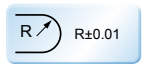
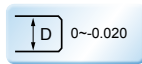
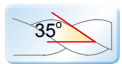
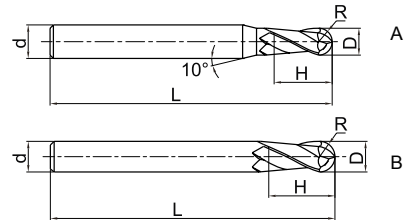

Type Typ	Dimension(mm) Abmessungen					Teeth Zähne Z	Geometry Ausführung	Grade Sorte YK30F
	D	R	d	H	L			
AL-2B-R1.0	2.0	1.0	6.0	4.0	60	2	A	○
AL-2B-R1.5	3.0	1.5	6.0	6.0	60	2	A	○
AL-2B-R2.0	4.0	2.0	6.0	8.0	60	2	A	○
AL-2B-R2.5	5.0	2.5	6.0	10.0	60	2	A	○
AL-2B-R3.0	6.0	3.0	6.0	12.0	60	2	B	○
AL-2B-R4.0	8.0	4.0	8.0	16.0	75	2	B	○
AL-2B-R5.0	10.0	5.0	10.0	20.0	75	2	B	○
AL-2B-R6.0	12.0	6.0	12.0	24.0	75	2	B	○

AL-2B

Workpiece material <i>Werkstückmaterial</i>	Aluminum alloy <i>Alu Legierungen</i>		Silicon aluminium alloy Si≤10% <i>Silizium Alu Legierungen Si≤10%</i>	
Diameter Ø <i>Durchmesser</i> (mm)	Rotating <i>Drehzahl</i> (min ⁻¹)	Feed <i>Vorschub</i> (mm/min)	Rotating <i>Drehzahl</i> (min ⁻¹)	Feed <i>Vorschub</i> (mm/min)
R1.0	40000	2000	32000	1600
R1.5	26500	1950	21000	1550
R2.0	20000	1950	16000	1550
R2.5	16000	1950	13000	1550
R3.0	13000	2000	10600	1600
R4.0	10000	2450	8000	2000
R5.0	8000	2200	6500	1750
R6.0	6600	2050	5300	1650
Max. cutting depth <i>max Schnitttiefe</i>				

1. Please select high rigid and precise machine and tool holder. Vibration and unusual noise may be generated if the machine rigidity and workpiece fixture stability is low, please reduce the rotating speed and feed stated above correspondingly.
2. It is possible to increase the rotating speed and feed correspondingly if the cutting depth is small.
3. Please use water-soluble cutting liquid.
4. Make overhang as short as possible if no interference.

1. Bitte Maschine und Werkzeugaufnahme mit hoher Präzision und Stabilität wählen. Bei Vibrationen oder unüblichen Geräuschen reduzieren Sie die Schnittdaten (wie oben empfohlen) entsprechend.
2. Schnittdaten bei kleinen Schnitttiefen erhöhen.
3. Bitte wasserlösliche Kühlmittel verwenden.
4. Die Werkzeugauskrantung so kurz wie möglich wählen.

Milling · Fräsen

Solid Carbide end mills · Vollhartmetallschaftfräser

NM-2B

2-flute ball nose mills with straight shank
2-Schneiden Kugelkopffräser mit Zylinderschaft

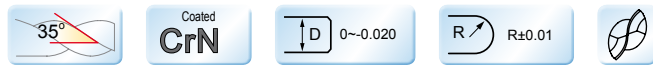
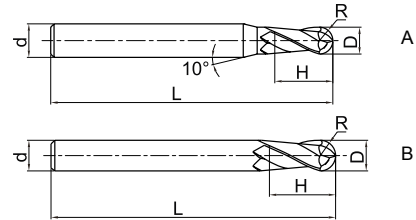

Type Typ	Dimension (mm) Abmessungen					Teeth Zähne Z	Geometry Ausführung	Grade Sorte KMG309
	D	R	d	H	L			
NM-2B-R0.5	1.0	0.5	4.0	2.0	50	2	A	●
NM-2B-R0.75	1.5	0.75	4.0	3.0	50	2	A	●
NM-2B-R1.0	2.0	1.0	4.0	4.0	50	2	A	●
NM-2B-R1.25	2.5	1.25	4.0	5.0	50	2	A	●
NM-2B-R1.5	3.0	1.5	6.0	6.0	50	2	A	●
NM-2B-R1.75	3.5	1.75	6.0	8.0	50	2	A	●
NM-2B-R2.0	4.0	2.0	6.0	8.0	50	2	A	●
NM-2B-R2.5	5.0	2.5	6.0	10.0	50	2	A	●
NM-2B-R3.0	6.0	3.0	6.0	12.0	50	2	B	●
NM-2B-R4.0	8.0	4.0	8.0	16.0	60	2	B	●
NM-2B-R5.0	10.0	5.0	10.0	20.0	75	2	B	●
NM-2B-R6.0	12.0	6.0	12.0	24.0	75	2	B	●

NM-2B

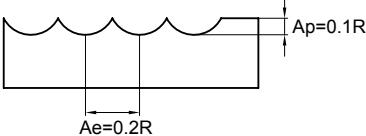
Workpiece material Werkstückmaterial	Copper / Copper alloy Kupfer / Kupferlegierung		
Diameter Ø Durchmesser (mm)	Rotating Drehzahl (min ⁻¹)	Feed Vorschub (mm/min)	
R0.5	40000	900	
R0.75	32000	800	
R1.0	24000	870	
R1.25	19000	800	
R1.5	16000	850	
R1.75	14000	850	
R2.0	12000	900	
R2.5	9600	900	
R3.0	8000	1200	
R4.0	7000	1500	
R5.0	4800	1300	
R6.0	4000	1200	
Max. cutting depth max Schnitttiefe			

1. Please select high rigid and precise machine and tool holder. Vibration and unusual noise may be generated if the machine rigidity and workpiece fixture stability is low, please reduce the rotating speed and feed stated above correspondingly.
2. It is possible to increase the rotating speed and feed correspondingly if the cutting depth is small.
3. Please use water-soluble cutting liquid.
4. Make overhang as short as possible if no interference.

1. Bitte Maschine und Werkzeugaufnahme mit hoher Präzision und Stabilität wählen. Bei Vibrationen oder unüblichen Geräuschen reduzieren Sie die Schnittdaten (wie oben empfohlen) entsprechend.
2. Schnittdaten bei kleinen Schnitttiefen erhöhen.
3. Bitte wasserlösliche Kühlmittel verwenden.
4. Die Werkzeugauskrägung so kurz wie möglich wählen.

Milling · Fräsen

Solid Carbide end mills · Vollhartmetallschaftfräser

AL-2R-AIR

2-flute end mills with straight shank
2-Schneiden Schafffräser mit Zylinderschaft



Ultrahigh speed HSC

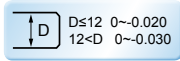
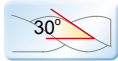
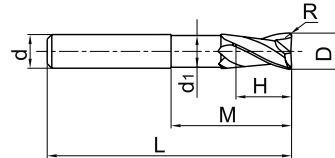

Type Typ	Dimension(mm) Abmessungen							Teeth Zähne Z	YK40F
	D	R	d	d ₁	H	M	L		
AL-2R-D6.0R1.0- AIR	6	1.0	6	5.5	7	20	57	2	●
AL-2R-D8.0R1.0- AIR	8	1.0	8	7.4	9	26	63	2	●
AL-2R-D10.0R1.0- AIR	10	1.0	10	9.2	11	31	72	2	●
AL-2R-D10.0R2.0- AIR	10	2.0	10	9.2	11	31	72	2	●
AL-2R-D12.0R1.0- AIR	12	1.0	12	11	12	37	83	2	●
AL-2R-D12.0R2.0- AIR	12	2.0	12	11	12	37	83	2	●
AL-2R-D12.0R3.0- AIR	12	3.0	12	11	12	37	83	2	●
AL-2R-D16.0R1.0- AIR	16	1.0	16	15	16	43	92	2	●
AL-2R-D16.0R2.0- AIR	16	2.0	16	15	16	43	92	2	●
AL-2R-D16.0R3.0- AIR	16	3.0	16	15	16	43	92	2	●
AL-2R-D16.0R4.0- AIR	16	4.0	16	15	16	43	92	2	●
AL-2R-D20.0R1.0- AIR	20	1.0	20	19	20	53	104	2	●
AL-2R-D20.0R2.0- AIR	20	2.0	20	19	20	53	104	2	●
AL-2R-D20.0R3.0- AIR	20	3.0	20	19	20	53	104	2	●
AL-2R-D20.0R4.0- AIR	20	4.0	20	19	20	53	104	2	●
AL-2R-D20.0R5.0- AIR	20	5.0	20	19	20	53	104	2	●
AL-2R-D20.0R6.0- AIR	20	6.0	20	19	20	53	104	2	●

● Ex Stock / ab Lager ○ On demand / auf Anfrage

AL-2R-AIR

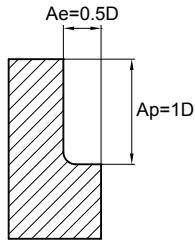
Workpiece material Werkstückstoff	Aluminum alloy Alu Legierungen		Silicon aluminium alloy Si≤10% Silizium Alu Legierungen Si≤10%	
Cutting speed Schnittgeschw.	500~800m/min		500~800m/min	
Diameter Ø Durchmesser (mm)	Rotating Drehzahl (min ⁻¹)	Feed Vorschub (mm/min)	Rotating Drehzahl (min ⁻¹)	Feed Vorschub (mm/min)
6	35000	3500	35000	3500
8	26000	3800	26000	3800
10	21000	4000	21000	4000
12	18000	4300	18000	4300
16	15000	4800	15000	4800
20	12000	5500	12000	5500
Max. cutting depth max Schnitttiefe	 <p>The diagram illustrates the maximum cutting parameters for the end mill. It shows a cross-section of a workpiece being machined. The axial cutting depth is labeled as $A_e = 0.5D$, where D is the diameter of the end mill. The radial cutting depth is labeled as $A_p = 1D$.</p>			

1. The cutting parameters above are applied for high speed machining Al alloy.
2. Please use cutting liquid or strong air blow to remove chips.
3. Sparks generated during machining process or heat caused by tool breakage may cause burning or fire. Please be careful of fireproof.
4. Dynamic balance test must be done before machining.

1. Obige Schnittdaten sind Hochgeschwindigkeits-Schnittdaten für die Bearbeitung von Alu Legierungen.
2. Bitte Kühlschmiermittel oder Luft mit hohem Druck zur Spanabfuhr benutzen.
3. Während der Bearbeitung kann durch Funken Feuer entstehend. Bitte Vorkehrungen treffen.
4. Dynamische Auswuchtvorschriften beachten.

Milling · Fräsen

Solid Carbide end mills · Vollhartmetallschaftfräser

AL-2RL-AIR for air space industry · für Luft- und Raumfahrt - Industrie

2-flute radius end mills with long straight shank
2-Schneiden Radiusfräser mit langem Zylinderschaft



Ultrahigh speed HSC

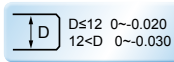
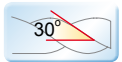
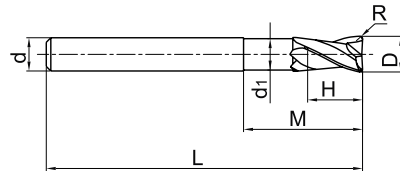

Type Typ	Dimension(mm) Abmessungen							Teeth Zähne Z	YK40F
	D	R	d	d ₁	H	M	L		
AL-2RL-D6.0R1.0- AIR	6	1.0	6	5.5	7	43	80	2	●
AL-2RL-D8.0R1.0- AIR	8	1.0	8	7.4	9	53	90	2	●
AL-2RL-D10.0R1.0- AIR	10	1.0	10	9.2	11	59	100	2	●
AL-2RL-D10.0R2.0- AIR	10	2.0	10	9.2	11	59	100	2	●
AL-2RL-D12.0R1.0- AIR	12	1.0	12	11	12	74	120	2	●
AL-2RL-D12.0R2.0- AIR	12	2.0	12	11	12	74	120	2	●
AL-2RL-D12.0R3.0- AIR	12	3.0	12	11	12	74	120	2	●
AL-2RL-D16.0R1.0- AIR	16	1.0	16	15	16	84	140	2	●
AL-2RL-D16.0R2.0- AIR	16	2.0	16	15	16	84	140	2	●
AL-2RL-D16.0R3.0- AIR	16	3.0	16	15	16	84	140	2	●
AL-2RL-D16.0R4.0- AIR	16	4.0	16	15	16	84	140	2	●
AL-2RL-D20.0R1.0- AIR	20	1.0	20	19	20	89	140	2	●
AL-2RL-D20.0R2.0- AIR	20	2.0	20	19	20	89	140	2	●
AL-2RL-D20.0R3.0- AIR	20	3.0	20	19	20	89	140	2	●
AL-2RL-D20.0R4.0- AIR	20	4.0	20	19	20	89	140	2	●
AL-2RL-D20.0R5.0- AIR	20	5.0	20	19	20	89	140	2	●
AL-2RL-D20.0R6.0- AIR	20	6.0	20	19	20	89	140	2	●

● Ex Stock / ab Lager ○ On demand / auf Anfrage

AL-2RL-AIR

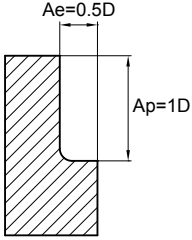
Workpiece material Werkstückstoff	Aluminum alloy Alu Legierungen		Silicon aluminium alloy Si≤10% Silizium Alu Legierungen Si≤10%	
Cutting speed Schnittgeschw.	500~800m/min		500~800m/min	
Diameter Ø Durchmesser (mm)	Rotating Drehzahl (min ⁻¹)	Feed Vorschub (mm/min)	Rotating Drehzahl (min ⁻¹)	Feed Vorschub (mm/min)
6	30000	3000	30000	3000
8	24000	3200	24000	3200
10	20000	3500	20000	3500
12	16000	3800	16000	3800
16	12000	4000	12000	4000
20	10000	4600	10000	4600
Max. cutting depth max Schnitttiefe	 <p>The diagram illustrates the maximum cutting depth parameters for the end mill. It shows a cross-section of the tool cutting into a workpiece. The axial cutting depth is labeled as $A_e = 0.5D$, where D is the diameter of the tool. The radial cutting depth is labeled as $A_p = 1D$.</p>			

1. The cutting parameters above are applied for high speed machining Al alloy.
2. Please use cutting liquid or strong air blow to remove chips.
3. Sparks generated during machining process or heat caused by tool breakage may cause burning or fire. Please be careful of fireproof.
4. Dynamic balance test must be done before machining.

1. Obige Schnittdaten sind Hochgeschwindigkeits-Schnittdaten für die Bearbeitung von Alu Legierungen.
2. Bitte Kühlschmiermittel oder Luft mit hohem Druck zur Spanabfuhr benutzen.
3. Während der Bearbeitung kann durch Funken Feuer entstehen. Bitte Vorkehrungen treffen.
4. Dynamische Auswuchtvorschriften beachten.

Milling · Fräsen

Indexable Milling Tools · Wendeplattenfräser

AL-3R-AIR for air space industry · für Luft- und Raumfahrt - Industrie

3-flute radius end mills with straight shank
3-Schneiden Radiusfräser mit langem Zylinderschaft



Ultrahigh speed

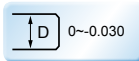
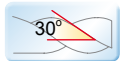
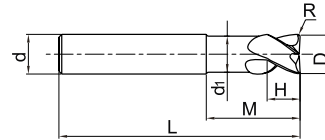

Type Typ	Dimension(mm) Abmessungen							Teeth Zähne Z	YK40F
	D	R	d	d ₁	H	M	L		
AL-3R-D12.0R1.0- AIR	12	1.0	12	11	12	37	83	3	●
AL-3R-D12.0R2.0- AIR	12	2.0	12	11	12	37	83	3	●
AL-3R-D12.0R3.0- AIR	12	3.0	12	11	12	37	83	3	●
AL-3R-D16.0R1.0- AIR	16	1.0	16	15	16	43	92	3	●
AL-3R-D16.0R2.0- AIR	16	2.0	16	15	16	43	92	3	●
AL-3R-D16.0R3.0- AIR	16	3.0	16	15	16	43	92	3	●
AL-3R-D16.0R4.0- AIR	16	4.0	16	15	16	43	92	3	●
AL-3R-D20.0R1.0- AIR	20	1.0	20	19	20	53	104	3	●
AL-3R- D20.0R2.0- AIR	20	2.0	20	19	20	53	104	3	●
AL-3R- D20.0R3.0- AIR	20	3.0	20	19	20	53	104	3	○
AL-3R- D20.0R4.0- AIR	20	4.0	20	19	20	53	104	3	●
AL-3R- D20.0R5.0- AIR	20	5.0	20	19	20	53	104	3	●
AL-3R- D20.0R6.0- AIR	20	6.0	20	19	20	53	104	3	●

● Ex Stock / ab Lager ○ On demand / auf Anfrage

AL-3R-AIR

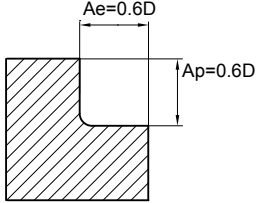
Workpiece material <i>Werkstückstoff</i>	Aluminum alloy <i>Alu Legierungen</i>		Silicon aluminium alloy Si≤10% <i>Silizium Alu Legierungen Si≤10%</i>	
Cutting speed <i>Schnittgeschw.</i>	800~1200m/min		800~1200m/min	
Diameter Ø Durchmesser (mm)	Rotating Drehzahl (min ⁻¹)	Feed Vorschub (mm/min)	Rotating Drehzahl (min ⁻¹)	Feed Vorschub (mm/min)
12	25000	6000	25000	6000
16	20000	6400	20000	6400
20	15000	7000	15000	7000
Max. cutting depth <i>max Schnitttiefe</i>	 <p>The diagram illustrates the maximum cutting depth parameters for a milling operation. It shows a cross-section of a workpiece being milled. The axial cutting depth is labeled as $A_e = 0.6D$, and the radial cutting depth is labeled as $A_p = 0.6D$. The workpiece is shown with hatching to indicate the material being removed.</p>			

1. The cutting parameters above are applied for high speed machining Al alloy.
2. Please use cutting liquid or strong air blow to remove chips.
3. Sparks generated during machining process or heat caused by tool breakage may cause burning or fire. Please be careful of fireproof.
4. Dynamic balance test must be done before machining.

1. Obige Schnittdaten sind Hochgeschwindigkeits-Schnittdaten für die Bearbeitung von Alu Legierungen.
2. Bitte Kühlschmiermittel oder Luft mit hohem Druck zur Spanabfuhr benutzen.
3. Während der Bearbeitung kann durch Funken Feuer entstehen. Bitte Vorkehrungen treffen.
4. Dynamische Auswuchtvorschriften beachten.

Milling · Fräsen

Solid Carbide end mills · Vollhartmetallschaftfräser

AL-3RL-AIR

3-flute radius end mills with long straight shank
3-Schneiden Radiusfräser mit langem Zylinderschaft



Ultrahigh speed HSC

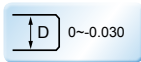
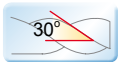

Type Typ	Dimension(mm) Abmessungen							Teeth Zähne Z	YK40F
	D	R	d	d ₁	H	M	L		
AL-3RL-D12.0R1.0- AIR	12	1.0	12	11	12	74	120	3	●
AL-3RL-D12.0R2.0- AIR	12	2.0	12	11	12	74	120	3	●
AL-3RL-D12.0R3.0- AIR	12	3.0	12	11	12	74	120	3	●
AL-3RL-D16.0R1.0- AIR	16	1.0	16	15	16	84	140	3	●
AL-3RL-D16.0R2.0- AIR	16	2.0	16	15	16	84	140	3	●
AL-3RL-D16.0R3.0- AIR	16	3.0	16	15	16	84	140	3	●
AL-3RL-D16.0R4.0- AIR	16	4.0	16	15	16	84	140	3	●
AL-3RL-D20.0R1.0- AIR	20	1.0	20	19	20	89	140	3	●
AL-3RL- D20.0R2.0- AIR	20	2.0	20	19	20	89	140	3	●
AL-3RL- D20.0R3.0- AIR	20	3.0	20	19	20	89	140	3	●
AL-3RL-D20.0R4.0- AIR	20	4.0	20	19	20	89	140	3	●
AL-3RL- D20.0R5.0- AIR	20	5.0	20	19	20	89	140	3	●
AL-3RL- D20.0R6.0- AIR	20	6.0	20	19	20	89	140	3	●

● Ex Stock / ab Lager ○ On demand / auf Anfrage

AL-3RL-AIR

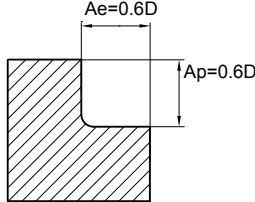
Workpiece material <i>Werkstückstoff</i>	Aluminum alloy <i>Alu Legierungen</i>		Silicon aluminium alloy Si≤10% <i>Silizium Alu Legierungen Si≤10%</i>	
Cutting speed <i>Schnittgeschw.</i>	800~1200m/min		800~1200m/min	
Diameter Ø <i>Durchmesser</i> (mm)	Rotating <i>Drehzahl</i> (min ⁻¹)	Feed <i>Vorschub</i> (mm/min)	Rotating <i>Drehzahl</i> (min ⁻¹)	Feed <i>Vorschub</i> (mm/min)
12	22000	5300	22000	5300
16	18000	5700	18000	5700
20	13000	6000	13000	6000
Max. cutting depth <i>max. Schnitttiefe</i>	 <p>The diagram illustrates the maximum cutting depth parameters for a milling operation. It shows a cross-section of a workpiece being machined by a tool. The axial cutting depth is labeled as $A_e = 0.6D$, and the radial cutting depth is labeled as $A_p = 0.6D$, where D is the diameter of the tool.</p>			

1. The cutting parameters above are applied for high speed machining Al alloy.
2. Please use cutting liquid or strong air blow to remove chips.
3. Sparks generated during machining process or heat caused by tool breakage may cause burning or fire. Please be careful of fireproof.
4. Dynamic balance test must be done before machining.

1. Obige Schnittdaten sind Hochgeschwindigkeits-Schnittdaten für die Bearbeitung von Alu Legierungen.
2. Bitte Kühlschmiermittel oder Luft mit hohem Druck zur Spanabfuhr benutzen.
3. Während der Bearbeitung kann durch Funken Feuer entstehen. Bitte Vorkehrungen treffen.
4. Dynamische Auswuchtvorschriften beachten.



Scan for PDF

Machining of aluminium and non-ferrous metals *Bearbeitung von Aluminium und NE-Metallen*

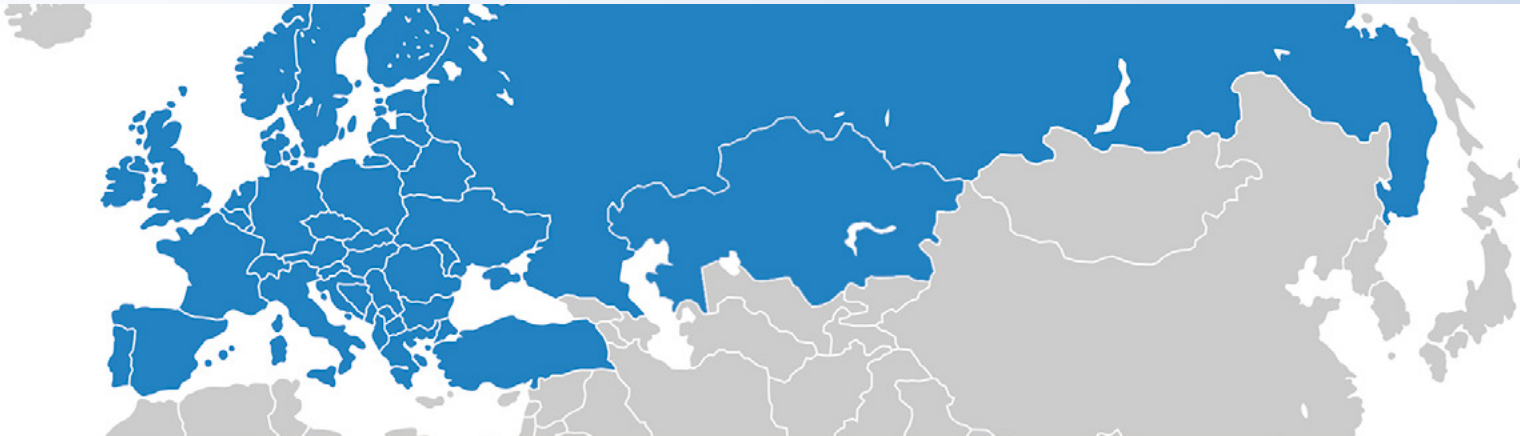

Sales center in Europe
Vertriebszentrale in Europa

ZCC Cutting Tools Europe GmbH

www.zccct-europe.com

Wanheimer Str. 57, 40472 Düsseldorf, Germany

Tel.: +49 (0) 211-989240-0

Fax: +49 (0) 211-989240-111

E-Mail: info@zccct-europe.com

Sales center in France
Vertriebszentrale in Frankreich

ZCC Cutting Tools Europe GmbH Succursale Française

www.zccct-europe.com

14, Allée Charles Pathé, 18000 Bourges, France

Tel.: +33 (0)2-454101-40

Fax: +33 (0)2-486619-46

E-Mail: ventes@zccct-europe.com

© Copyright by ZCC Cutting Tools Europe GmbH
All rights reserved / Alle Rechte vorbehalten.

All rights reserved. All descriptions and pictures are protected by copyright. Usage, modification and reproduction, completely or partially, without written permission are prohibited. Subject to technical changes and changes of the delivery program. Mistakes and printing errors are reserved.

Alle Rechte vorbehalten. Alle Beschreibungen und Abbildungen sind urheberrechtlich geschützt. Die Verwendung, Modifikation und Vervielfältigung, ganz oder teilweise, ohne schriftliche Genehmigung sind untersagt. Technische Änderungen und Änderungen des Lieferprogrammes vorbehalten. Für Druckfehler und Irrtümer keine Gewähr.